

PERFORMANCE OF COMPRESSED AIR ENGINE MODIFIED FROM SPARK IGNITION ENGINE WITH CAM MODIFICATION

By:

BARATHAN BASKARAN

Matrix Number: 120362

Supervisor

Professor Dr. Haji Zainal Alimuddin Bin Haji Zainal Alauddin

May 2017

This dissertation is submitted to
Universiti Sains Malaysia
As partial fulfillment of the requirement to graduate with honors degree in
BACHELOR OF ENGINEERING (MECHANICAL ENGINEERING)



School of Mechanical Engineering
Engineering Campus
Universiti Sains Malaysia

DECLARATION

This work has not previously been accepted in substance for any degree and is not being concurrently submitted in candidature for any degree.

Signed BARATHAN BASKARAN

Date 26th May 2017

STATEMENT 1

This journal is the result of my own investigation, except where otherwise stated. Other sources are acknowledged by giving explicit reference. Bibliography/references are appended.

Signed BARATHAN BASKARAN

Date 26th May 2017

STATEMENT 2

I hereby give consent for my journal, if accepted, to be available for photocopying and for interlibrary loan, and for the title and summary to be made available outside organization.

Signed BARATHAN BASKARAN

Date 26th May 2017

ACKNOWLEDGEMENT

After undergone countless efforts and discussion, I am grateful to the God for the good health and wellbeing that were necessary to complete this research. My deepest appreciation and gratitude goes to my supervisor of the final year project Professor Dr. Haji Zainal Alimuddin Bin Haji Zainal Alauddin for the valuable guidance and advice as well as encouragements along the project. This project would not be completed without the help from my supervisor. Also I would like to express my special thanks to technicians from School of Mechanical Engineering especially Mr. Mohd Zalmi Bin Yop who helped me a lot with my project. He helped me a lot in explaining and assisting me on the engine and assembly part. Next I would also like to thank my family or always giving me encouragement throughout this project duration. Last but not least, I would like to thank all the people who had involved directly and indirectly in helping me during the project.

Title of thesis : **Performance of Compressed Air Engine Modified from Spark Ignition Engine with Cam Modification**

Date of submission : **May 2017**

Candidate : **Barathan Baskaran**

Supervisor : **Professor Dr. Haji Zainal Alimuddin Bin Haji Zainal Alauddin**

TABLE OF CONTENT

	Page
DECLARATION	i
ACKNOWLEDGEMENT	ii
TABLE OF CONTENT	iii
LIST OF TABLES	iv
LIST OF FIGURES	iv
ABSTRAK	vi
ABSTRACT	vii
1.0 INTRODUCTION	
1.1 Air Compressor Engine	1
1.2 4 Stroke Engine vs. 2 Stroke Engine	2
1.3 CAM & Valve	3
1.4 Rope Brake Dynamometer	5
2.0 METHODOLOGY	
2.1 Valve Duration	7
2.2 Cam Profile and Duration	8
2.3 Engine Efficiency	9
3.0 RESULTS & DISCUSSION	
3.1 Valve Duration	13
3.2 Cam Profile and Duration	14
3.3 Energy Efficiency	17
4.0 CONCLUSION	28
5.0 REFERENCE	29

LIST OF TABLES

	Page
Table 1: Material Friction Coefficient	6
Table 2: Lobe Lift	15
Table 4: Suggested Lobe Lift	16

LIST OF FIGURES

	Page
Fig. 1: Valve Timing Diagram for Gasoline engine	3
Fig. 2: Lobe Design	4
Fig. 3: Common Valve Timing	5
Fig. 4: Set up of experiment to determine Valve Timing	7
Fig. 5: Dial gage Indicator on Valve	8
Fig. 6: Protractor fixed on flywheel	8
Fig. 7: Set up of experiment to determine Cam Timing	9
Fig. 8: Split Hub on Flywheel	9
Fig. 9: Schematic Diagram of Air Supply System Setup	10
Fig. 10: Setup of system to the engine	10
Fig. 11: Schematic Diagram of Leather Belt Setup on Flywheel	11
Fig. 12: Setup of Leather Belt on Flywheel	11
Fig. 13: Valve Circle Diagram – Flywheel Rotation	13
Fig. 14: Overlap of Intake & Exhaust Valve	14
Fig. 15: Cam Circle Diagram – Cam Shaft Rotation	15
Fig. 16: Cam Profile	15
Fig. 17: Suggested Cam Circle Diagram – Cam Shaft Rotation	16
Fig. 18: Suggested Cam Profile	17
Fig. 19: Brake Power vs Flow Rate at Different RPM (3 Bar)	18
Fig. 20: Indicated Power vs Flow Rate (3 Bar)	18
Fig. 21: Frictional Power vs Flow Rate at Different RPM (3 Bar)	19

Fig. 22: Mechanical Efficiency vs Flow Rate at Different RPM (3 Bar)	19
Fig. 23: Brake Power vs Flow Rate at Different RPM (4 Bar)	20
Fig. 24: Indicated Power vs Flow Rate (4 Bar)	20
Fig. 25: Frictional Power vs Flow Rate at Different RPM (4 Bar)	21
Fig. 26: Mechanical Efficiency vs Flow Rate at Different RPM (4 Bar)	21
Fig. 27: Brake Power vs Flow Rate at Different RPM (5 Bar)	22
Fig. 28: Indicated Power vs Flow Rate (5 Bar)	22
Fig. 29: Frictional Power vs Flow Rate at Different RPM (5 Bar)	23
Fig. 30: Mechanical Efficiency vs Flow Rate at Different RPM (5 Bar)	23
Fig. 31: Brake Power vs Flow Rate at Different RPM (6 Bar)	24
Fig. 32: Indicated Power vs Flow Rate (6 Bar)	24
Fig. 33: Frictional Power vs Flow Rate at Different RPM (6 Bar)	25
Fig. 34: Mechanical Efficiency vs Flow Rate at Different RPM (6 Bar)	25
Fig. 35: Mechanical Efficiency vs Pressure at Different RPM (250L/min)	26

ABSTRAK

Tenaga yang tidak boleh diperbaharui akan berkurangan dari semasa ke semasa, meningkatkan pelbagai pencemaran di seluruh dunia mewujudkan suasana yang tidak seimbang. Pembangunan teknologi untuk mengatasi keadaan ini telah pun bermula. Salah satu inovasi adalah untuk mewujudkan enjin di mana bahan api yang digunakan adalah udara yang dimampatkan. Enjin yang digunakan terutamanya untuk penyelidikan ini adalah HONDA G200 4 lejang minyak petrol di mana ia telah diubahsuai kepada enjin 2 lejang untuk meningkatkan kuasa dan kecekapan. 'Cam lobe' telah diubah suai demi untuk menukar 4 lejang kepada 2 lejang. Sebagai bahan api yang digunakan iaitu udara yang dimampatkan, bertindih dalam injap dan cam akan menyebabkan kehilangan kuasa kerana sejumlah udara yang dimampat yang masuk melalui port pengambilan akan segera keluar melalui port ekzos tanpa melalui kitaran. Kehilangan kuasa akan menyebabkan enjin menjadi kurang cekap. Tujuan projek ini adalah untuk menentukan adakah cam dan injap telah bertindih dan berapakah tempoh pertindihan. Kemudian, sistem brek Dynamometer digunakan untuk menentukan kecekapan enjin. Brek Dynamometer, mengukur tork keluaran atau tork memandu yang diperlukan enjin. Bagi projek ini khususnya, tali pinggang kulit telah digunakan dan bukannya kabel untuk pekali geseran yang lebih rendah. Akhirnya, ia telah ditentukan bahawa injap dan cam mempunyai isu pertindihan dan cadangan yang dibuat ke atas bagaimana untuk menghapuskan pertindihan untuk minimum. Kecekapan mekanikal enjin adalah dalam lingkungan 7% kepada 28% pada pembolehubah yang berbeza digunakan.

ABSTRACT

As non-renewable energy depletes as the day goes by, increasing variety pollutions all around the world creating an unbalanced atmosphere. Development of technologies to overcome this situation has been already begun. One of the innovations is to create an engine where the fuel used is compressed air. The engine used particularly for this research is the HONDA G200 4 stroke gasoline engine where it has been modified to a 2 stroke engine to increase power and efficiency. The cam lobe has been modified in order to convert 4 stroke to 2 stroke engine. As the fuel used is compressed air, overlap in valve and cam would cause power loss because a certain amount of compressed air that comes through the intake port will immediately exit through exhaust port without going through the cycle. Power loss will cause the engine to be less efficient. The aim of this project is to determine does the cam and valve have overlap and how much is the duration of the overlap. Then, a rope brake dynamometer system was used to determine the engine's efficiency. A rope brake dynamometer, measures the output torque or the required driving torque of the engine. As for this particular project, a leather belt was used instead a cable for a lower friction coefficient. In the end, it was determined that the valve and cam has an overlap issue and suggestions are made on how to eliminate the overlap to minimal. The mechanical efficiency of the engine was in the range of 7% to 28% at a different variable used.

1.0 INTRODUCTION

1.1 Air Compressor Engine

Nonrenewable energy products which meet the majority of the world's vitality request today are being exhausted from our crust at a high rate. Their exhausted emissions are leading greenhouse effect, decrease in ozone layer lining, global warming and acid rains. These pose a threat to our environment and mankind. Sustainability wouldn't be achieved if this problem grows continuously. Charles B. Hodges [1], the father of compressed air concept applied to car is the first to invent a functional car by a compressed air engine and considered to commercialize it. The first air powered car was made in 1926 by Lee Barton Williams. The car can go on gasoline up until it hit 10 MPH then the gas shut off and air powered the car. A compressed air engine (CAE) is powered by using compressed air, which is stored in a tank. Instead of mixing fuel with air and burning it in the engine to drive pistons with hot expanding gases; compressed-air vehicles use the expansion of compressed air to drive their pistons [2, 3]. Compressed-air propulsion may also be incorporated in hybrid systems, e.g., battery electric propulsion and fuel tanks to recharge the batteries. This kind of system is called hybrid-pneumatic electric propulsion. Additionally, regenerative braking can also be used in conjunction with this system [2]. In a research conducted at National Tsing Hua University [4], A 100 cc IC engine was modified from four strokes to two strokes for compressed air operation. The intake system of compressed air engine was examined at different intake valve timings, -10° to 80° , -10° to 120° , and -10° to 150° . The power outputs of different intake valve timings were recorded at different supply air pressures and rotational speeds. A ball valve installed before the engine intake port is to control the speed of motorcycle by adjusting the air flow rate. In this study, the success of motorcycle test drive with compressed air engine demonstrates the feasibility of vehicle applications; however, it also shows the problem of short range with limited air supply and also due to the low energy density of compressed air.

For this project, compressed air will be used on the Honda G200 engine as fuel replacing gasoline. This would achieve the sustainability goal.

1.2 4 Stroke Engine vs. 2 Stroke Engine

All through the historical backdrop of car configuration, there have existed two principle sorts of fuel combustion engines, the 2 cycle (2 stroke) and 4 cycle (4 strokes) engines. The names of every engine recommend precisely how they work. For an engine to complete combustion there should be burning of the gas-air mixture and ejection through exhaust. A 2 cycle engine completes a combustion and exhaust cycle in only 2 strokes of the piston, with a 4 cycle taking 4 strokes of the piston.

For a 4 cycle engine, there is a power stroke which is brought about by combustion of the fuel mixture. At that point there is an exhaust stroke that pushes the gas exhaust out of the engine. The following two strokes include an intake to draw in the fuel and a compression stroke to start the process all over again. Examining this process closer yields the observation that the whole cycle is powered by the initial combustion stroke. This means that the combustion of the fuel mixture needs to impart enough power

A 2 cycle engine has substantially more straightforward mechanics, as it essentially combines the distinctive process of a 4 stroke engine. There is power stroke which additionally discharges the exhaust after a specific measure of travel, then an intake and pressure stroke that attracts new fuel and finishes combustion. Observing the efficiency, a 4 stroke engine accomplishes incredible efficiency because of the way that almost no fuel is wasted in the intake cycle. In a 2 stroke, since the fuel is drawn in during a combined intake and compression stroke, the mechanics required for this additionally imply that some fuel can escape while being drawn into the cylinder, diminishing efficiency. Modern 2 strokes utilize fuel injection which expands their productivity to levels near the 4 stroke, however for the most part, a 4 stroke can be a great deal of efficiency.

Efficiency isn't all that matters, however, a 4 stroke is unquestionably more proficient, yet they additionally measure upwards of half more than a practically identical 2 stroke motor. This weight is because of greater complexity inside the engine's system, which additionally prompts essentially all the more moving parts in a 4 cycle. As far as effortlessness and effectiveness to settle, a 2 stroke easily wins out.

1.3 CAM & Valve

The change of one of the basic movements, for example, rotation, into some other movements is regularly helpfully fulfilled by methods for a cam mechanism. A cam mechanism more often than not comprises of two moving components, the cam and the follower, mounted on a fixed frame. Cam gadgets are flexible, and any self-assertively indicated movement can be gotten. In a few examples, they offer the least complex and most minimized approach to change movements. A cam might be characterized as a machine component having a curved outline or a curved groove, which, by its oscillation or rotation motion, gives a predetermined specified motion to another element called the follower.

The camshaft is the "heart" of the gasoline engine. The engine will not perform to its highest potential unless the cam is precision ground to provide performance at the speeds required [5]. The valve timing diagram for the conventional 4-stroke engine is shown in Fig. 1. The angles (usually measured in crankshaft degrees) when the valves first leave and then return to their seats are used to prepare valve timing diagrams and termed as opening and closing angles. The opening and closing angles may also refer to a specified nominal lift, e.g. at 0.050 in cam lift. A cam's timing may be stated as 25-65-65-25. These numbers are (1) intake opening before T.D.C., (2) intake closing after B.D.C, (3) exhaust opening before B.D.C. and (4) exhaust closing after T.D.C. For these numbers to have meaning, the lift at which the numbers are taken must be specified. The purpose of the cam lobe is to raise the lifter and open the valve. Lob design for conventional engine is shown in Fig. 2.

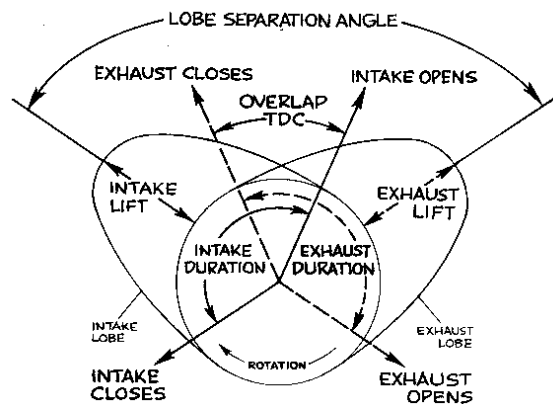

Fig. 1: Valve Timing Diagram for Gasoline engine

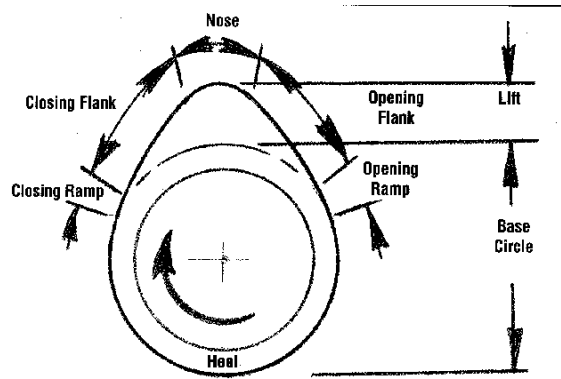

Fig. 2: Lobe Design

Overlap is the angle in crankshaft degrees that both the intake and exhaust valves are open. This occurs at the end of the exhaust stroke and the beginning of the intake stroke. Increasing lift duration and/or decreasing lobe separation increases overlap. At high engine speeds, overlap allows the rush of exhaust gasses out the exhaust valve to help pull the fresh air/fuel mixture into the cylinder through the intake valve. Increased engine speed enhances the effect. Increasing overlap increases top-end power and reduces low-speed power idle quality. A research conducted at Gujarat, India [6] and Jabalpur, India [7], where it was stated that from the comparison of the cycles of conventional IC engine and pneumatic engine, it is evident that the intervals for operation of the inlet and outlet valves are different. The valves must operate twice for retrofitted engine as compared to those of conventional engine. Thus the cam for the retrofitted 2-stroke pneumatic engine must have double lift i. e. for 360° of rotation; cam must actuate the valve twice. The design of valve timings and cam profile allows conversion of conventional 4-stroke IC engine into 2-stroke pneumatic engine. Further research was not concluded stating on its pneumatic engine efficiency.

Valve Timing is a system developed for measuring valve operation in relation to crank shaft position (in degrees), particularly the points when the valves open, how long they remain open, and when they close. Valve timing is probably the single most important factor in tailoring an engine for special needs. An engine can be made to produce its maximum power in various speed ranges by altering valve timing. Fig. 3 shows comparison of 4 stroke valve timing and 2 stroke valve timing.

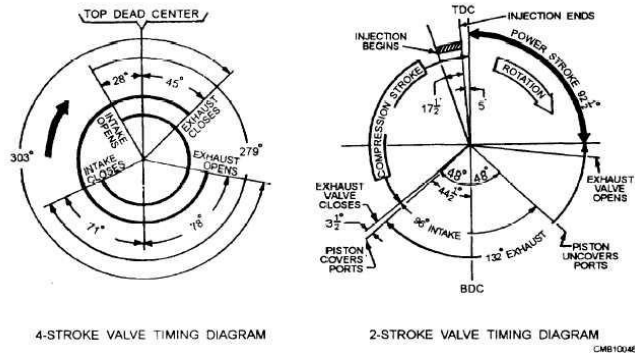

Fig. 3: Common Valve Timing

1.4 Rope Brake Dynamometer

A dynamometer, or "dyno" for short, is a machine used to measure torque and rotational speed (rpm) from which power delivered by an engine or some other pivoting prime mover can be calculated [8]. Dynamometer is an instrument for measuring power applied by men and machines dynamometers are utilized or measurement of brake power. To quantify brake power, the engine torque and angular speed must be measured. The rotor is driven by the engine under test by mechanical, pressure driven or electromagnetic means. The rotor is coupled to the stator. For every revolution of the shaft, rotor covers the distance $2 \times R \times F$ against coupling force F . In the absorption dynamometers, the whole energy or power delivered by the motor is consumed by the friction resistances of the brake and is changed into heat, during the process of measurement. But in the transmission dynamometers, the energy is not wasted in friction but is used for doing work. The energy or power produced by the engine is transmitted through the dynamometer to some other machines where the power developed is suitably measured [8].

In a study from University of Engineering and Technology, Bangladesh [9, 10], it was found that variations of friction coefficient with the duration of rubbing at different normal loads and sliding velocities are investigated. Results show that friction coefficient varies with duration of rubbing, normal load and sliding velocity. In general, friction coefficient increases for a certain duration of rubbing and after that it remains constant for the rest of the experimental time. Moreover, the obtained results reveal that friction coefficient decreases with the increase in normal load for all the tested pairs. On the other hand, it is also found that friction coefficient increases with the increase in sliding velocity for all the material pairs.

The magnitudes of friction coefficient are different for different material pairs depending on sliding velocity and normal load. Reducing friction power in general would create more brake power instead thus the mechanical efficiency would be more.

Friction can be reduced by:-

- Reduce contact between surface
- Reduce the force acting on the surface
- Use proper lubrication
- Use a lower friction coefficient material

Table 1 shows the friction coefficient of two different metals that would be created when it comes in contact with each other [11]. The cable usually has a friction coefficient of 0.8-1 but leather has only around 0.6 of friction coefficient.

MATERIAL 1	MATERIAL 2	COEFFICIENT FRICTION
Aluminum	Aluminum	1.05-1.35
Aluminum	Mild Steel	0.61
Brake Material	Cast Iron	0.4
Brake Material	Cast Iron (Wet)	0.2
Cast Iron	Cast Iron	1.1
Cast Iron	Oak	
Chromium	Chromium	0.41
Copper	Cast Iron	1.05
Copper	Copper	1
Copper	Mild Steel	0.53
Graphite	Graphite	0.1

MATERIAL 1	MATERIAL 2	COEFFICIENT FRICTION
Graphite	Steel	0.1
Graphite (In vacuum)	Graphite (In vacuum)	0.5 - 0.8
Hard Carbon	Hard Carbon	0.16
Hard Carbon	Steel	0.14
Iron	Iron	1
Lead	Cast Iron	
Leather	Wood	0.3 - 0.4
Leather	Metal(Clean)	0.6
Leather	Metal(Wet)	0.4
Leather	Oak (Parallel grain)	0.61
Magnesium	Magnesium	0.6

Table 1: Material Friction Coefficient

2.0 METHODOLOGY

This experiment is divided into three parts which are:-

- 2.1 To determine the Valve timing
- 2.2 To determine the Cam timing
- 2.3 To determine the engine efficiency at different pressure, flow rate and RPM.

2.1 Valve Timing

The cylinder head cover was removed and a dial gauge indicator was placed on top of the valve as in Fig. 4 and Fig. 5. Two valve timings were taken which were the intake and exhaust valves. A 360° protractor was fixed on the middle of the flywheel using a nut as shown in Fig. 6. Flywheel was rotated to ensure the piston is at Top Dead Center (TDC) and protractor was adjusted to 0°. Flywheel was rotated by hand slowly. Once the dial gage indicator needle begun to move, the reading of angle on the protractor was noted down. It indicated the intake valve has opened. Flywheel was again rotated to determine the maximum intake valve lift. At TDC, the exhaust valve would still be opened depending on the engine, thus maintain the 0° at TDC, flywheel was rotated and angle was recorded for the exhaust valve close after TDC.



Fig. 4: Set up of experiment to determine Valve Timing

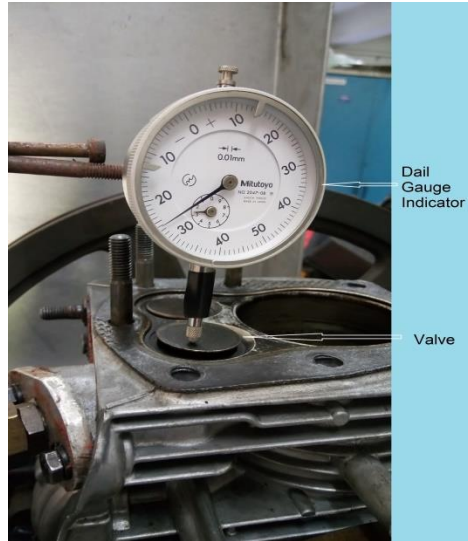

Fig. 5: Dial gage Indicator on Valve

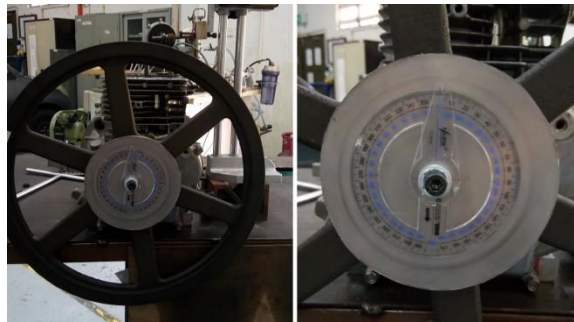

Fig. 6: Protractor fixed on flywheel

2.2 Cam Timing

As or the cam timing experiment, the cam shaft was removed from inside the engine. We can observe there are two types of cam lobe. One is the original steel lobe and the second is with the brass material fabricated on it. The cam shaft was placed on a V-block. A ruler was used to mark the both cam lobe parallel with the cam shaft with a line. This would indicate the starting point. Avoid marking on the cam lobe where the lift will occur. Instead it was marked on the base circle. The same dial gauge indicator was used and it was set on the mark of the intake cam. A suitable shaft was to set the protractor at the end of the camshaft. The setup is shown in Fig. 7.

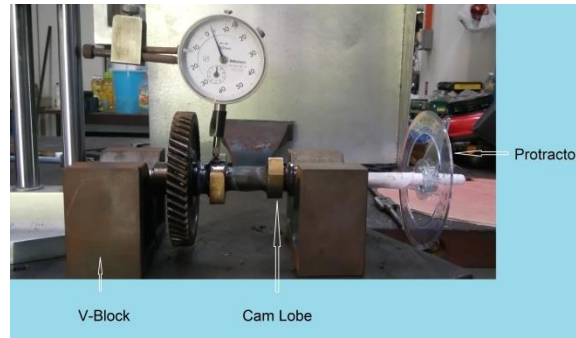

Fig. 7: Set up of experiment to determine Cam Timing

Experiment was begun by adjusting the protractor to 0° as the dial gage indicator of the intake cam is set on the line. Shaft was rotated slowly and as the indicator needle began to move as it reached the lift zone, the angle reading on the protractor was recorded as it indicated intake has begun to open. Shaft was rotated again to determine the maximum cam lift and the lift duration till intake closed. There are two sets of readings as there were two cam lobes on a single cam.

2.3 Engine Efficiency

For the rope brake dynamometer, there is a groove on the flywheel to channel the cable between it so that it would not slip elsewhere as tension is applied to the cable. The middle part of the flywheel is called the split hub Fig. 8. It is where the flywheel would be locked on the shaft of the engine. As for this experiment, a leather belt was used instead of a cable. The belt was placed on the split hub. This is to ensure, a lower surface area is obtained for the frictional power purpose.

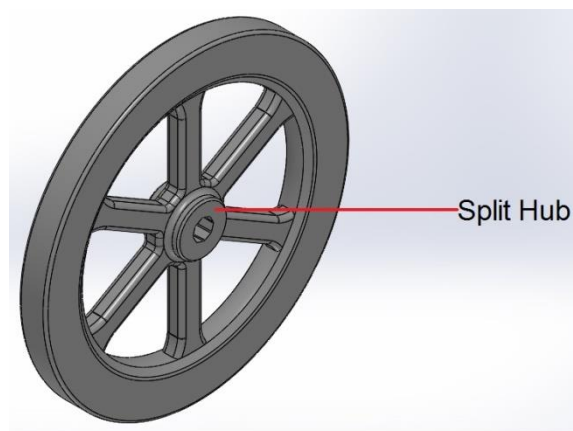

Fig. 8: Split hub on Flywheel

This part of experiment was the most important as it provided the data to determine the efficiency of this engine using the modified cam. As it was using compressed air as the fuel to run this engine, the supply was taken from the main line fixed at 8 bar. The air supply systems consist of rota meter, air pressure regulator and air pressure gauge. This was fixed to the intake opening of the engine. The setup is shown in Fig. 9 and Fig. 10.

The second part was to set the leather belt and electronic digital weigh balance to the split hub. A plate was fixed on the split hub to avoid the belt to slip off during experiment. The electronic digital weight balance was fixed on a hook which was attached to a plate with bolt and nut. The tension of the belt can be increased by tightening the bolt. The setup is shown in Fig. 11 and Fig. 12.

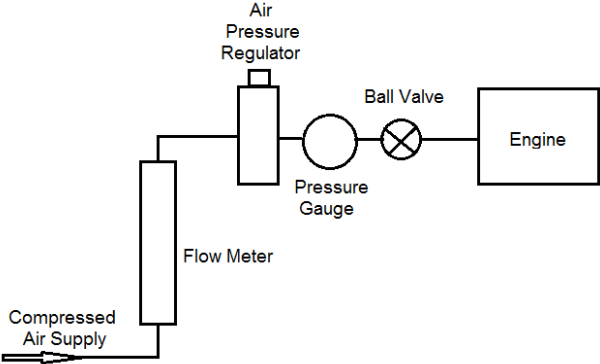

Fig 9: Schematic Diagram of Air Supply System Setup

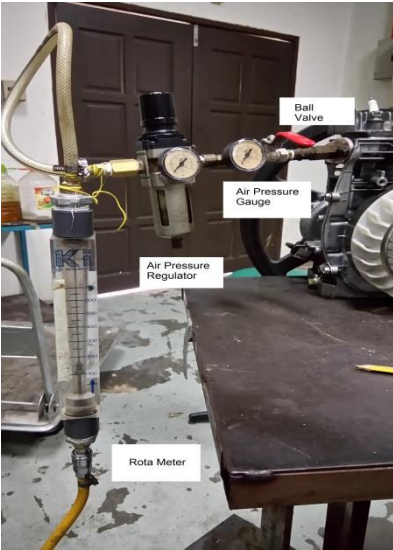

Fig. 10: Setup of system to the engine

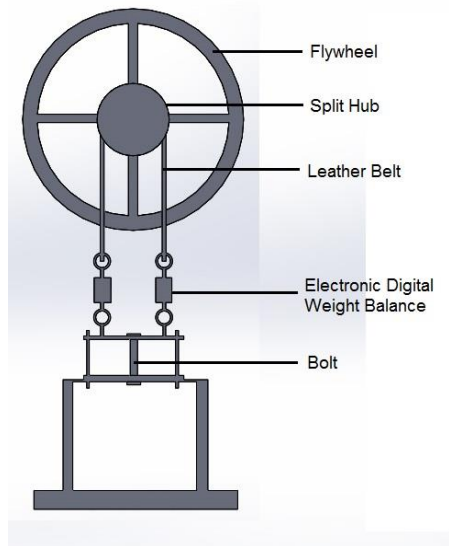

Fig 11: Schematic Diagram of Leather Belt Setup on Flywheel

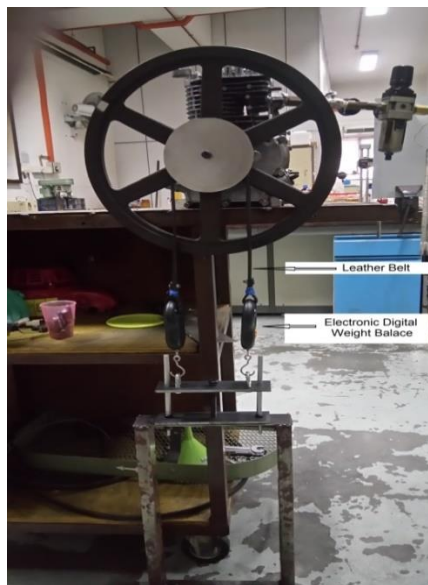

Fig. 12: Setup of Leather Belt on Flywheel

The main line compressed air valve was opened fully but the ball valve fixed near the engine was closed. The air pressure was adjusted to 3 bar. The ball valve was slowly opened and speed of the flywheel was recorded using a tachometer. Speed was set for 350, 400 and 450 rpm at the flow rate of 150, 200, 250 and 300 l/min. the tension of belt was adjusted by tightening the bolt to slow the speed of the flywheel. The reading of force applied on the belt on electronic digital weigh balances were taken

Using all the data, the torque, brake power, indicated power, frictional power and mechanical efficiency were calculated and plotted on graphs of brake power, indicated power, frictional power and mechanical efficiency against flow rate. The following are the equations used.

$$T = (W_1 - W_2) * (r_1 + r_2) \text{ Nm} \quad \text{Eq. 1}$$

$$BP = (2\pi NT)/60 \quad \text{Eq. 2}$$

$$IP = P * Q \quad \text{Eq. 3}$$

$$F = IP - BP \quad \text{Eq. 4}$$

$$\eta_m = BP/IP \quad \text{Eq. 5}$$

W_1	Mass shown on first electronic weigh balance	N
W_2	Mass shown on second electronic weigh balance	N
T	Torque	Nm
r_1	radius of flywheel	m
r_2	radius of leather belt	m
N	speed of flywheel	rpm
P	Pressure	N/m^2
Q	Flow rate	m^3/s
BP	Brake Power	watt
IP	Indicate Power	watt
FP	Frictional Power	watt
η_m	Mechanical efficiency	

3.0 RESULTS & DISCUSSION

3.1 Valve Duration

Fig. 13 shows the angle where the intake valve and exhaust valve opens and closes. The duration of the intake valve opens was 150° and duration of the exhaust valve opens was 254° . The intake valve open at 38° after TDC and closed at 8° after BDC. As for the exhaust valve, it open at 24° after BDC and closed at 82° before BDC. There is an overlap between the exhaust valve and intake valve. The overlap begins at 38° till 98° which means for a duration of 60° .

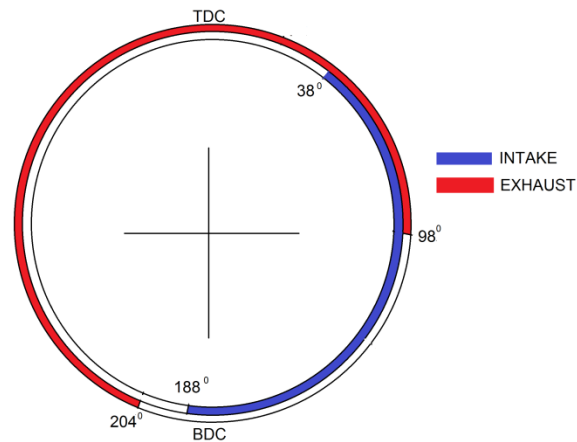

Fig. 13: Valve Circle Diagram – Flywheel Rotation

Another diagram shown in Fig. 14 is the actual picture taken of the valve overlap. The red highlighted region shows that the valve remained open. Valve overlap caused some of the compressed air that comes through the intake to exit straight through the exhaust opening without contributing to work. This would cause a slight power loss and drop of efficiency of the engine. Thus it is proven that this engine cycle has cam and valve overlap.

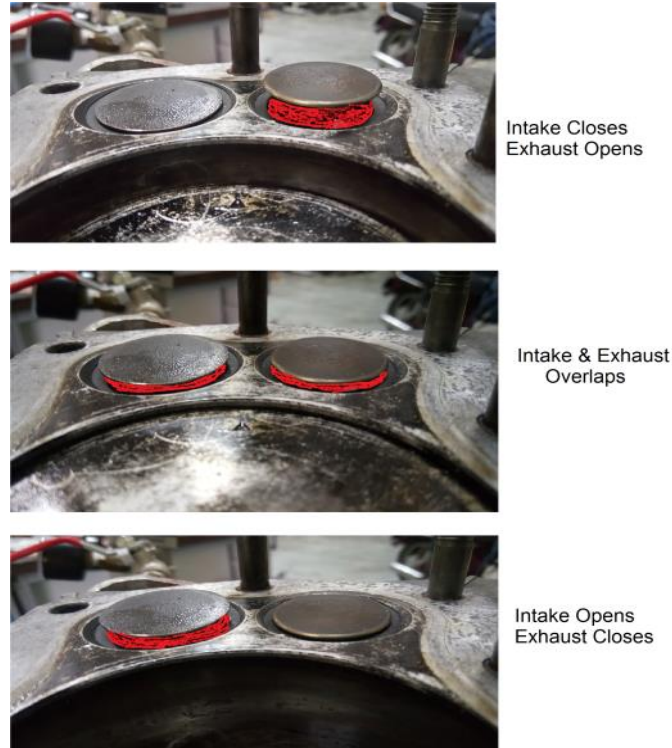

Fig. 14: Overlap of Intake & Exhaust Valve

3.2 CAM Profile & Duration

For the cam experiment, a circle diagram and cam profile was done indicating a more accurate drawing and reading of the overlap. Fig. 15 shows the cam circle diagram, Table 2 shows the amount of lift and Fig. 16 shows the cam profile.

Based on the cam profile and cam circle diagram, there was several cam overlap that had to take count. The first overlap was between intake brass cam lobe and exhaust steel cam lobe. It was from 63° to 103° thus the duration of overlap was 40° . The second overlap was between exhaust steel cam lobe and intake steel cam lobe. It was from 190° to 197° thus the duration was only 7° . It was the smallest overlap. The third overlap was between intake steel cam lobe and exhaust brass cam lobe. It was from 232° to 284° thus the duration was 52° . This part of experiment had proved the cam has overlap issue thus power loss is certain and the efficiency of engine would reduce.

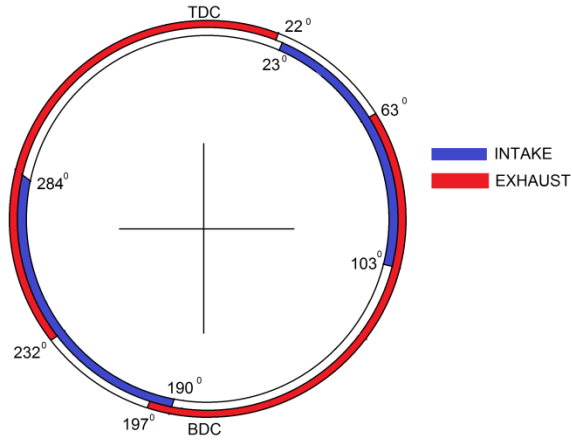

Fig. 15: Cam Circle Diagram – Cam Shaft Rotation

Cam Lobe - Material	Lobe Lift (mm)
Intake Steel	3.38
Intake Brass	3.64
Exhaust Steel	5.68
Exhaust Brass	5.95

Table 2: Lobe Lift

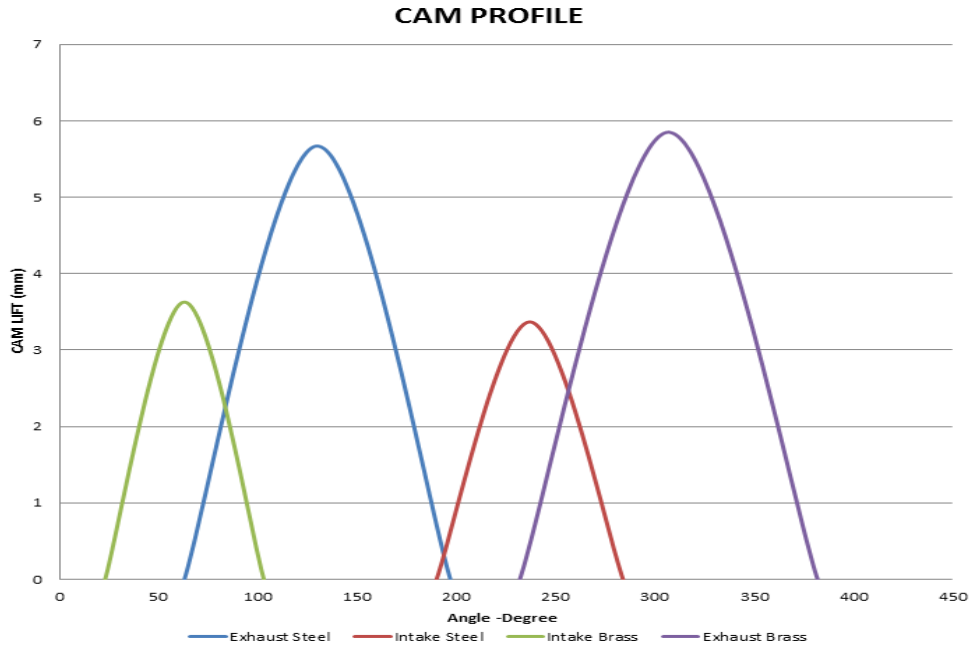

Fig. 16: Cam Profile

To avoid any power loss and reduction in engine efficiency, suggestion of grinding the both steel and brass exhaust cam lobe would be advisable. By grinding according the specification of cam lift and duration provided in Table 3, Fig. 17, and Fig. 18, it would be certain that the overlap would be reduced to minimal. After grinding, the cam lobe must be symmetrical as it would cause imbalance in opening and closing of valve incase the lobe was not grinded properly.

Cam Lobe - Material	Lobe Lift (mm)
Intake Steel	3.38
Intake Brass	3.64
Exhaust Steel	3.64
Exhaust Brass	3.38

Table 3: Suggested Lobe Lift

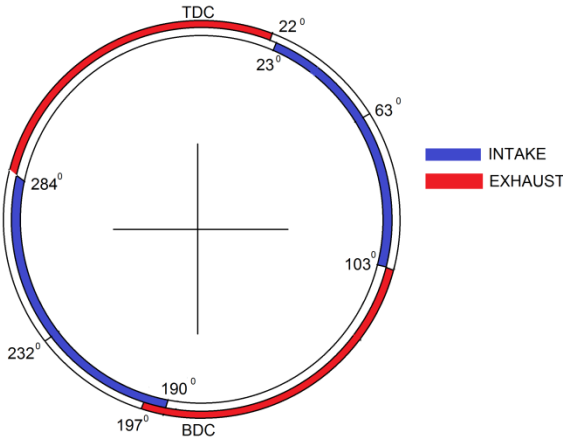

Fig. 17: Suggested Cam Circle Diagram – Cam Shaft Rotation

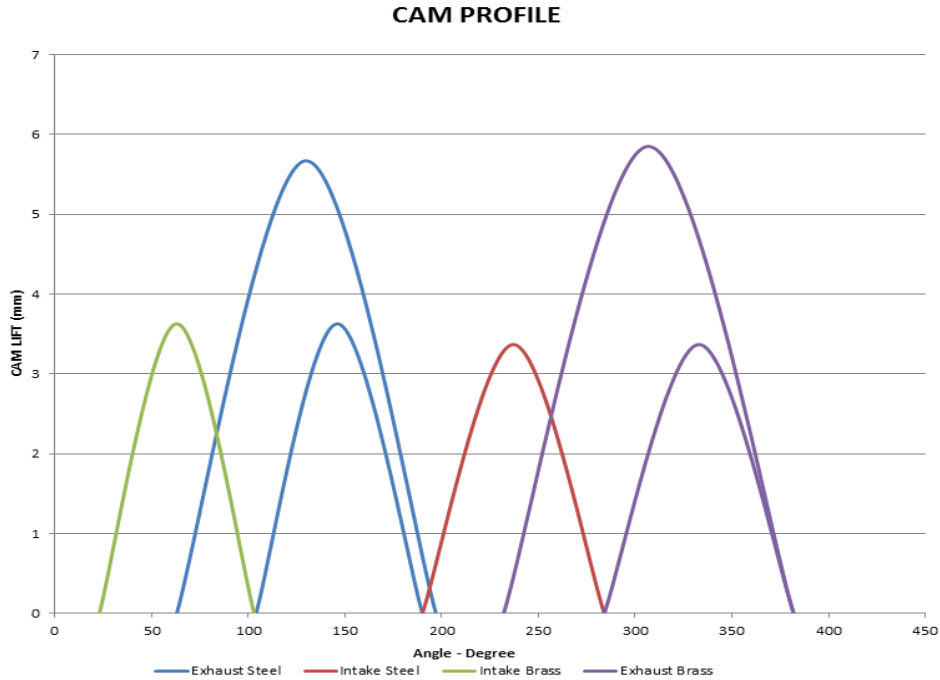

Fig. 18: Suggested Cam Profile

3.3 Engine Efficiency

At 3 bar, the brake power, frictional power and indicated power increases as the flow rate increases. The highest brake power achieved was 409.54watt which was at 450 RPM versus flow rate at 290 L/min. The highest frictional power is 1067.297watt at 350 RPM versus flow rate at 290 L/min. As for the mechanical efficiency of the engine, the range of lowest to highest efficiency conducted at 3 Bar would be from 22.09% to 28.24%. The highest efficiency is at 450RPM versus flow rate at 290L/min. Figs 19, 20, 21 and 22 shows the graph plotted for brake power, indicated power, frictional power and mechanical efficiency versus flow rate at different speed for 3 Bar respectively. After the 3 bar data, the plotted graphs continue for 4, 5 and 6 bars respectively.

3 Bar

Brake Power vs Flow Rate at Different RPM (3Bar)

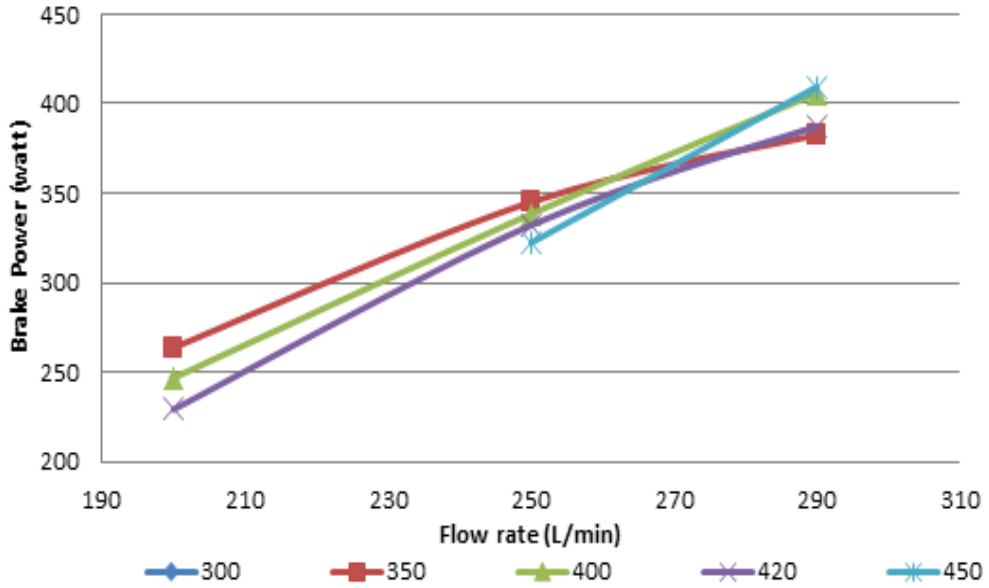

Fig. 19: Brake Power vs Flow Rate at Different RPM (3 Bar)

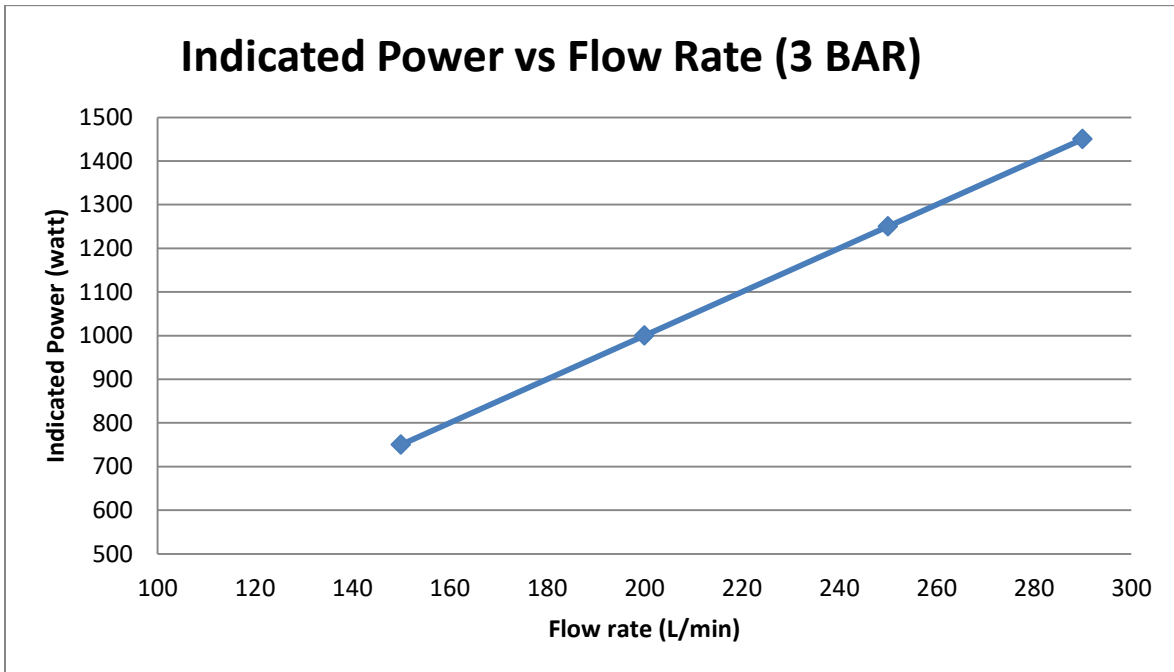

Fig. 20: Indicated Power vs Flow Rate (3 Bar)

Frictional Power vs Flow Rate at Different RPM (3 BAR)

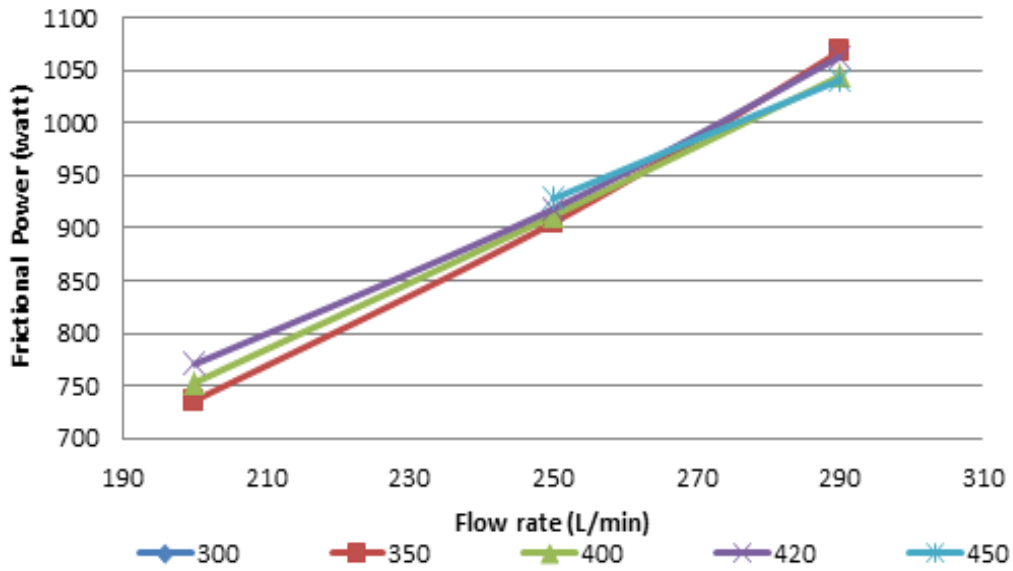

Fig. 21: Frictional Power vs Flow Rate at Different RPM (3 Bar)

Mechanical Efficiency vs Flow Rate at Different RPM (3 BAR)

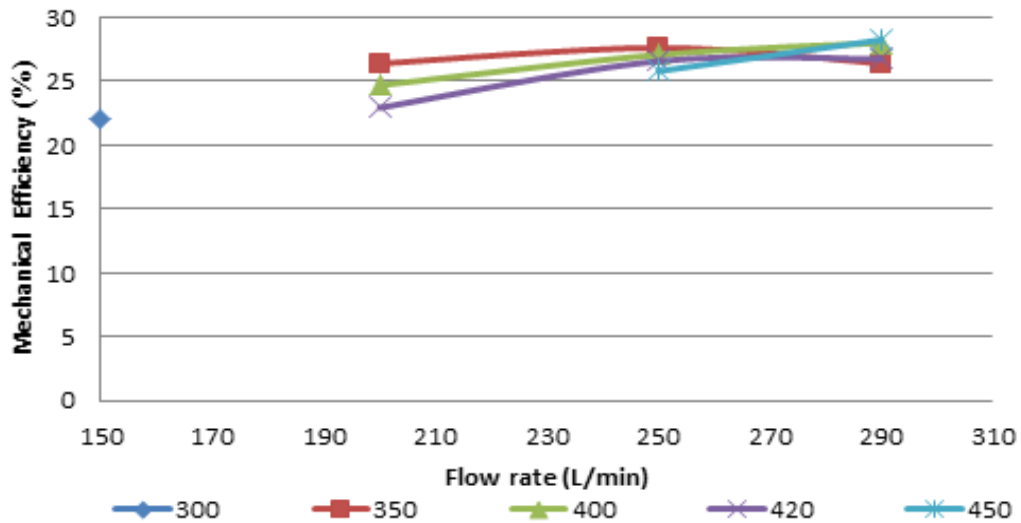

Fig. 22: Mechanical Efficiency vs Flow Rate at Different RPM (3 Bar)

4 Bar

Brake Power vs Flow Rate at Different RPM (4Bar)

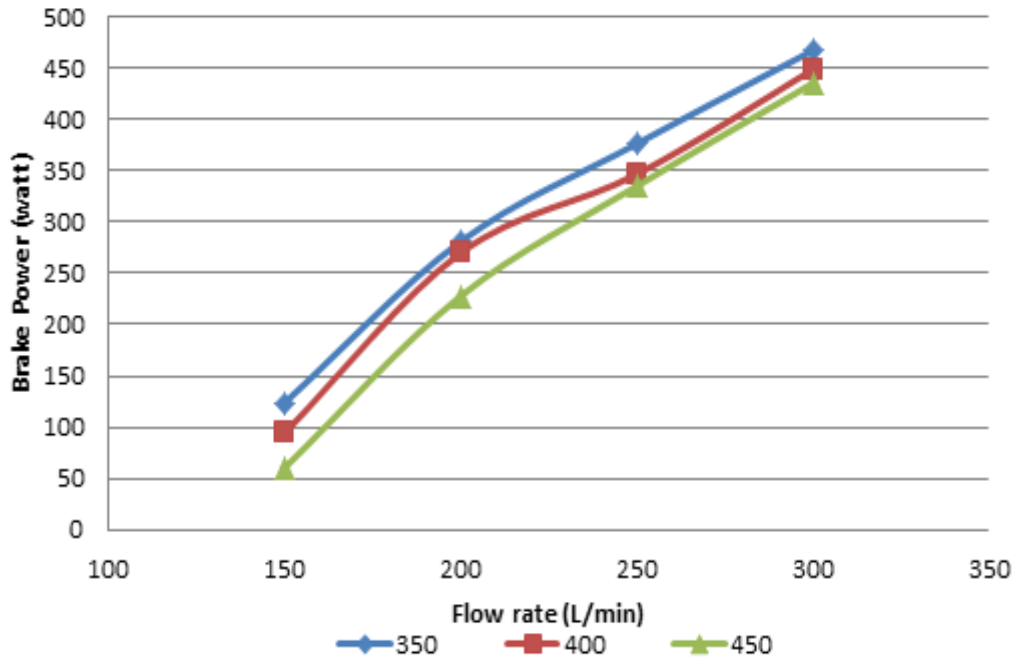

Fig. 23: Brake Power vs Flow Rate at Different RPM (4 Bar)

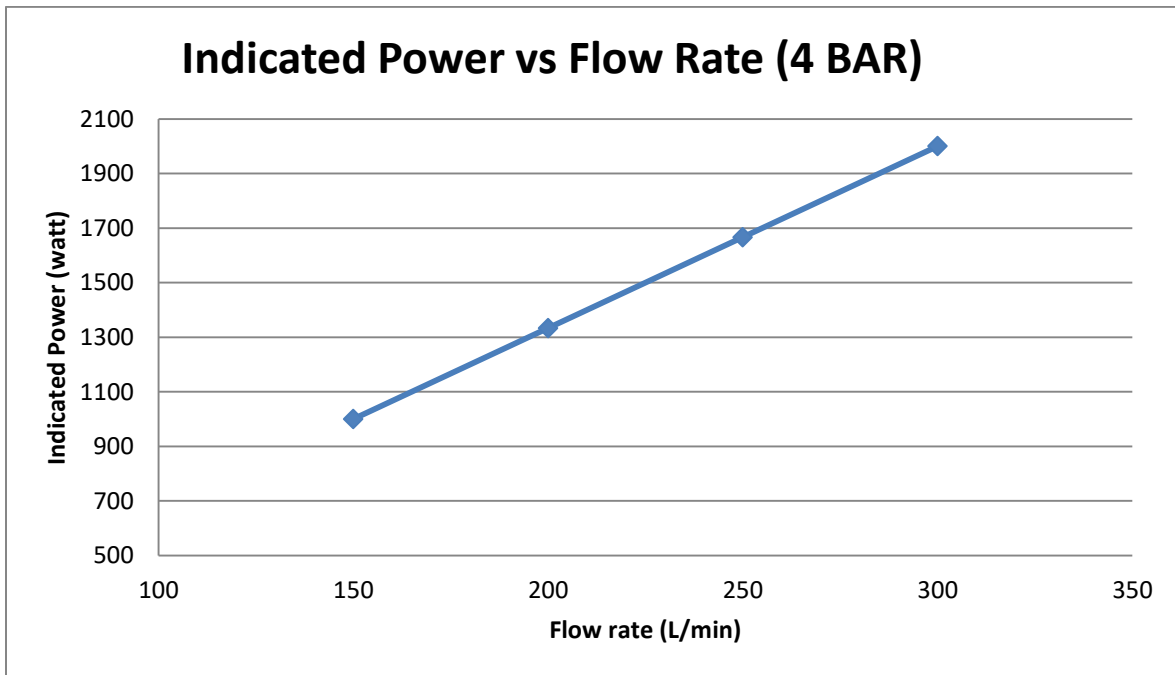

Fig. 24: Indicated Power vs Flow Rate (4 Bar)

Frictional Power vs Flow Rate at Different RPM (4 BAR)

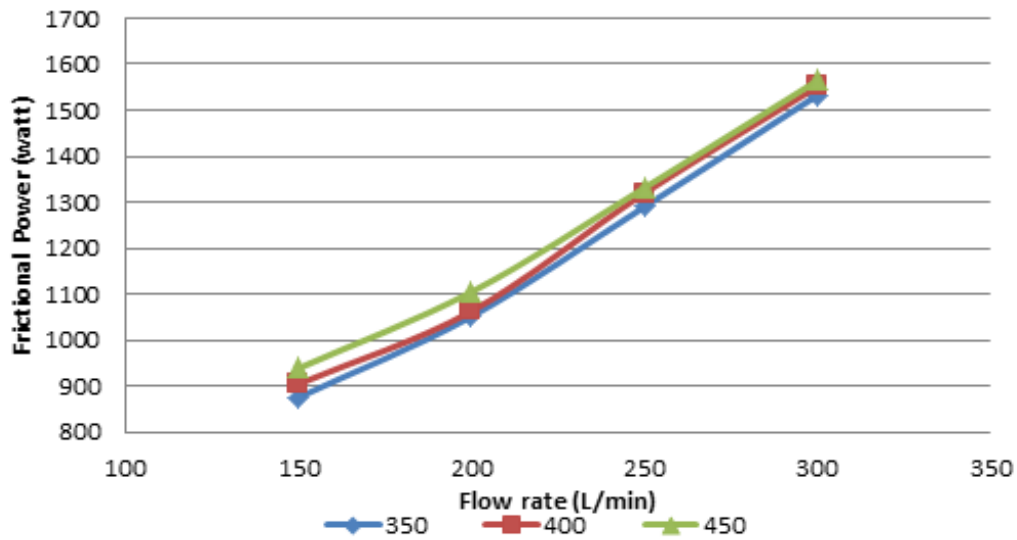

Fig. 25: Frictional Power vs Flow Rate at Different RPM (4 Bar)

Mechanical Efficiency vs Flow Rate at Different RPM (4 BAR)

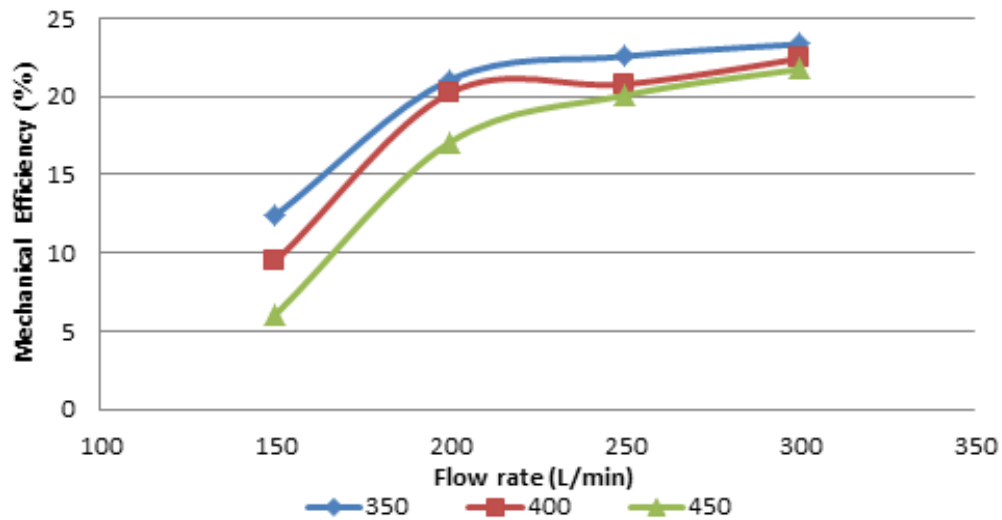

Fig. 26: Mechanical Efficiency vs Flow Rate at Different RPM (4 Bar)

5 Bar

Brake Power vs Flow Rate at Different RPM (5Bar)

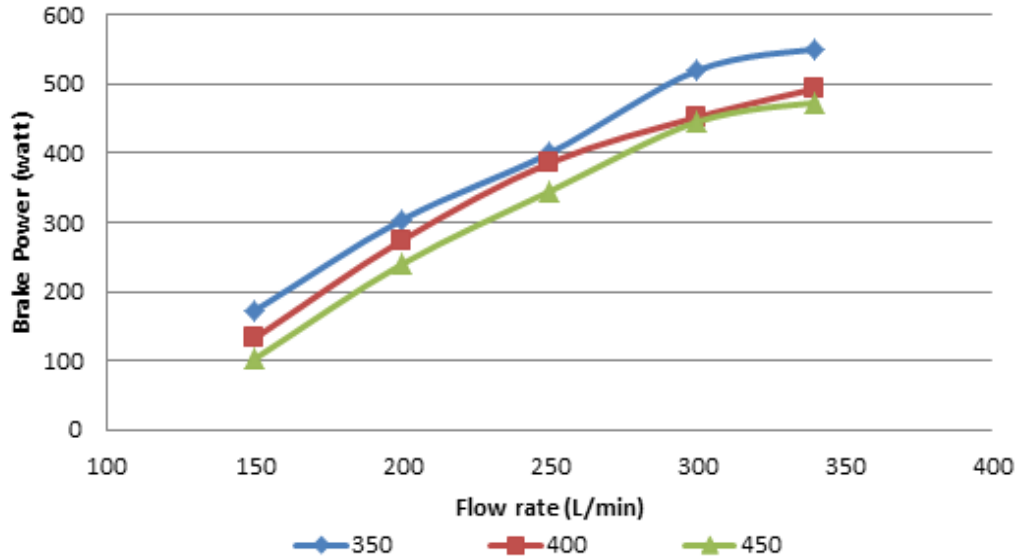

Fig. 27: Brake Power vs Flow Rate at Different RPM (5 Bar)

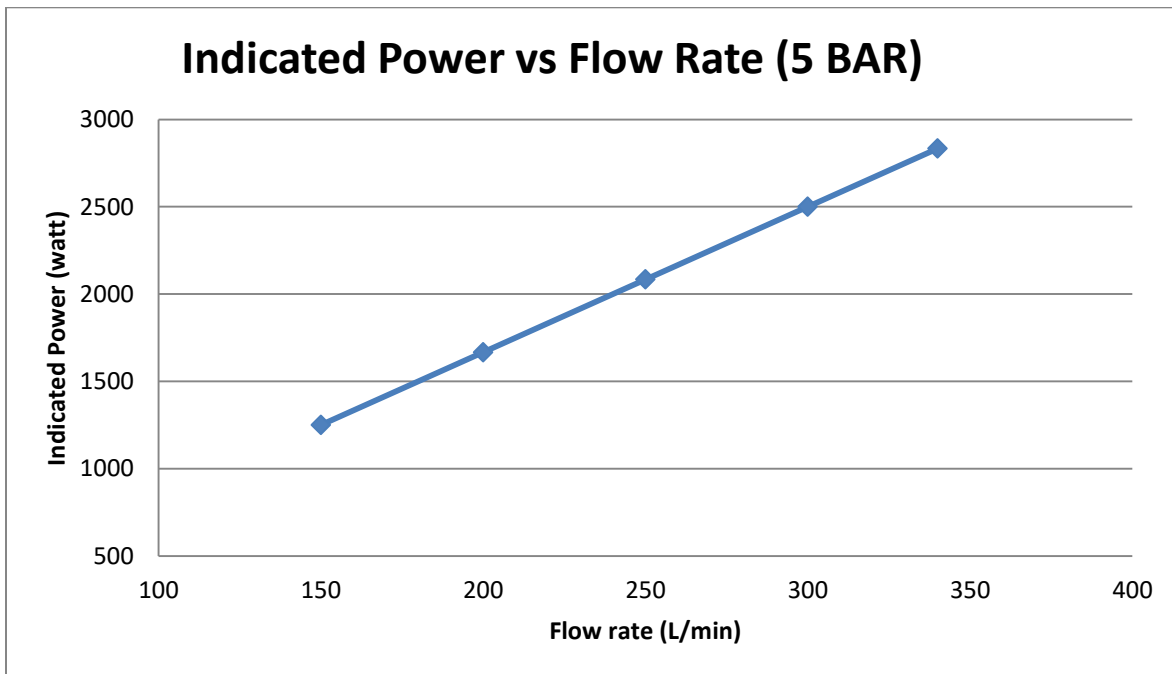

Fig. 28: Indicated Power vs Flow Rate (5 Bar)

Frictional Power vs Flow Rate at Different RPM (5 BAR)

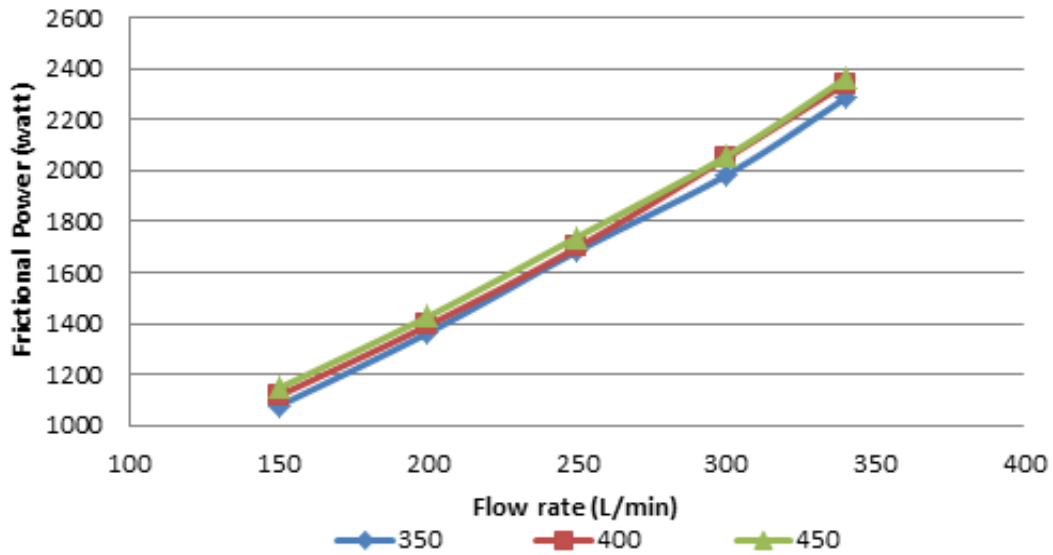

Fig. 29: Frictional Power vs Flow Rate at Different RPM (5 Bar)

Mechanical Efficiency vs Flow Rate at Different RPM (5 BAR)

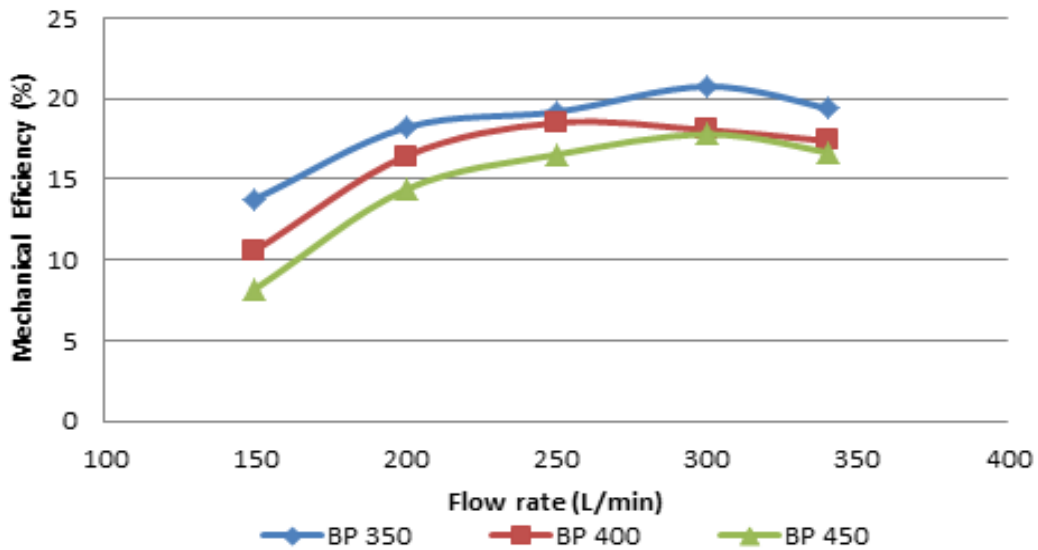

Fig. 30: Mechanical Efficiency vs Flow Rate at Different RPM (5 Bar)

6 Bar

Brake Power vs Flow Rate at Different RPM (6Bar)

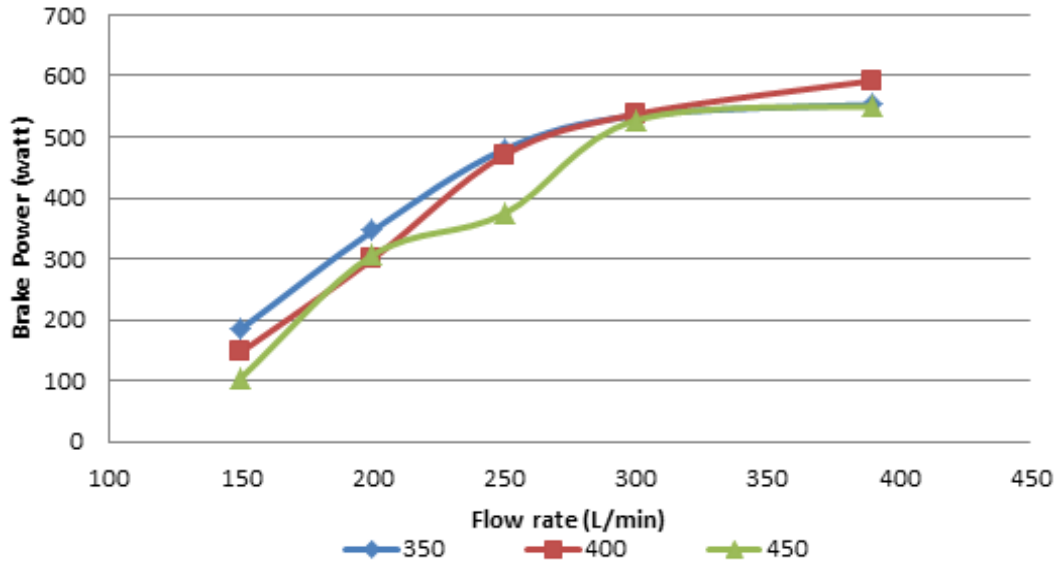

Fig. 31: Brake Power vs Flow Rate at Different RPM (6 Bar)

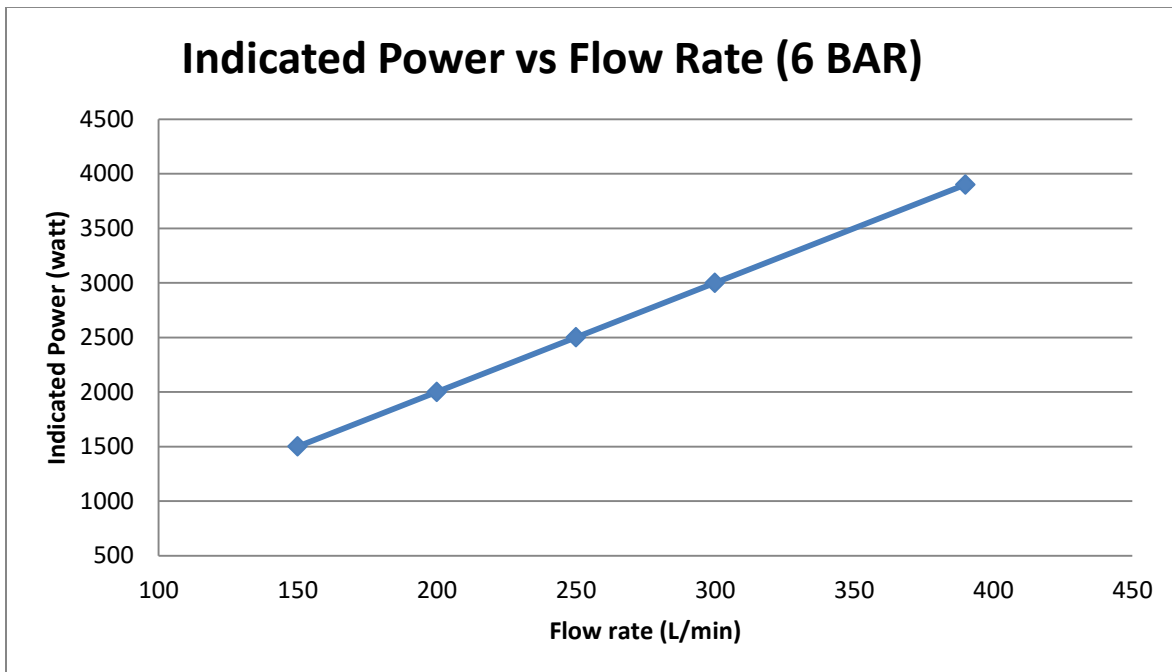

Fig. 32: Indicated Power vs Flow Rate (6 Bar)