

**CRYSTAL STRUCTURES AND ANALYSIS OF
1,2,4 TRIAZOLE
AND
PYRAZOLE COMPOUNDS**

by

GOH JIA HAO

**UNIVERSITI SAINS MALAYSIA
2011**

**CRYSTAL STRUCTURES AND ANALYSIS OF
1,2,4 TRIAZOLE
AND
PYRAZOLE COMPOUNDS**

by

GOH JIA HAO

**Thesis submitted in fulfillment of the requirements
for the Degree of
Master of Science**

June 2011

ACKNOWLEDGEMENTS

First of all, I owe my deepest gratitude to my family members who have given me the opportunity for postgraduate education. This thesis would not have been possible without their patience, understanding and spiritual support in realizing my dreams.

I am heartily thankful to my supervisor, Professor Fun Hoong Kun, whose supervisions, encouragements and supports from the preliminary to the final stage enabled me to complete my thesis successfully. His continual and convincing spirit of “Crystallography is Fun and Fun is Crystallography” in concern to research as well as teaching had enabled me to develop a thorough understanding of X-ray Crystallography. Besides that, I would like to dedicate my heartfelt gratitude also to my co-supervisor, Associate Professor Abdul Razak Ibrahim for his untiring effort, commitment and guidance throughout my studies.

In addition, I greatly thank Universiti Sains Malaysia and Institute of Postgraduate Studies, USM for a wide range of facilities and supports provided as well as the USM Fellowship awarded. Financial support provided by the Research University Golden Goose Grant (1001/PFIZIK/811012) and the Science Fund (305/PFIZIK/613312) are also acknowledged. Besides that, it is my pleasure to thank fellow researchers from India especially Professor B. Kalluraya and Associate Professor Arun M. Isloor, for providing research samples and cooperation in journal publications.

Last but not least, I am greatly appreciative of all members of X-ray Crystallography Unit, School of Physics, Universiti Sains Malaysia for their kind and helpful cooperation throughout my research in the laboratory.

TABLE OF CONTENTS

Acknowledgement	ii
Table of Contents	iii
List of Tables	x
List of Figures	xii
List of Plates	xvi
Abstrak	xvii
Abstract	xix

CHAPTER 1 – INTRODUCTION

1.1 X-ray Crystallography	1
1.2 1,2,4-Triazole Derivatives	3
1.2.1 Preparation of 1,2,4-Triazole Derivatives	4
1.2.2 Applications of 1,2,4-Triazole Derivatives	5
1.3 Pyrazole Derivatives	7
1.3.1 Preparation of Pyrazole Derivatives	8
1.3.2 Applications of Pyrazole Derivatives	8
1.4 Research Objective	10

CHAPTER 2 – BASIC PRINCIPLES OF X-RAY STRUCTURE ANALYSIS

2.1 Generation of X-rays	13
2.1.1 X-ray Tube	16
2.2 Crystal Systems	18
2.3 X-ray Diffraction	21
2.3.1 Reciprocal Lattice	23
2.3.2 Bragg's Law in Reciprocal Space	24
2.3.3 Argand Diagram	26
2.3.4 Combination of N waves	28
2.3.5 Phase Difference	29
2.3.6 Atomic Scattering Factors	29

2.3.7	Structure Factor	32
2.3.8	Friedel's Law	33
2.3.9	Limiting Conditions and Systematic Absences	36
2.4	Fourier Series	37
2.4.1	Electron Density and Structure Factor	40
2.4.2	Electron Density Equation	41
2.4.3	Interpretation of Electron Density Distribution	42
2.5	The Patterson Function	43
2.6	Direct Method	43
2.7	Data Reduction	47
2.7.1	Lorentz and Polarization Corrections	47
2.7.2	Absorption Corrections	48
2.7.3	Extinction	49
2.8	Structure Refinement	52
2.8.1	Least-Squares Refinement	52
2.8.2	Crystallographic <i>R</i> -values	54
2.8.3	Location and Treatment of Hydrogen Atoms	55
2.8.4	Residual Electron Density	56
2.9	Interpretation and Presentation of Results	57
2.9.1	Bond Lengths and Angles	57
2.9.2	Torsion Angle	58
2.9.3	Mean Planes and Interplanar Angle	60
2.9.4	Precision	60
2.9.5	Graphical Representations	61
2.10	Additional Topics	61
2.10.1	Disorders	61
2.10.1.1	Site Occupancy Disorder	62
2.10.1.2	Positional and Orientational Disorder	62
2.10.2	Ring Conformations	63
2.10.3	Limitations of X-ray Structure Analysis	65
2.10.4	<i>Cis-trans</i> Isomerism	66

CHAPTER 3 – MATERIALS AND METHODS

3.1	Introduction	67
3.2	APEXII System	67
3.2.1	Hardware Overview	67
3.2.1.1	APEXII Detector	70
3.2.1.2	Goniometer	71
3.2.1.3	X-ray Source	72
3.2.1.4	X-ray Generator	72
3.2.1.5	Timing Shutter and Collimator	73
3.2.1.6	Video Microscope	73
3.2.1.7	Radiation Safety Enclosure	74
3.2.1.8	Refrigerated Recirculator for the Detector	74
3.2.1.9	Computers	74
3.2.1.10	Cobra Low-Temperature Attachment	74
3.2.2	Software Overview	75
3.2.2.1	Bruker Instrument Service	75
3.2.2.2	APEX2	76
3.3	SHELXTL Software Package	77
3.3.1	XPREP – Space Group Determination	77
3.3.2	XS – Structure Solution	77
3.3.3	XL – Least-Squares Refinement	77
3.3.4	XP – Graphical Representation	78
3.4	Methods and Experiments	79
3.4.1	Choose and Mount a Crystal	80
3.4.2	Center and Screen a Crystal	81
3.4.2.1	Mount the Goniometer Head	81
3.4.2.2	Center a Crystal	82
3.4.2.3	Measure the Crystal Dimension	83
3.4.3	Data Collection	83
3.4.3.1	Create a New Directory	83

3.4.3.2	Phi 360° Simple Scan	83
3.4.3.3	Determine the Unit Cell	84
3.4.3.4	Refine the Data Collection Strategy	86
3.4.3.5	Collect Data/Run Experiment	87
3.4.4	Data Integration and Scaling	88
3.4.4.1	Integrate Data	88
3.4.4.2	Monitor the SaintChart	89
3.4.4.3	Scale Data	90
3.4.5	Space Group Determination	91
3.4.6	Structure Solution	94
3.4.7	Access the Solution	94
3.4.7.1	Edit the Instruction File	95
3.4.8	Least-Squares Refinement	97
3.4.8.1	Clean Up the Structure	98
3.4.8.2	Anisotropic Refinement	99
3.4.8.3	Refined Hydrogen Treatment	100
3.4.8.4	Idealized Hydrogen Treatment	101
3.4.8.5	Absorption Correction	102
3.4.8.6	Weighting Schemes	103
3.4.9	Graphical Representation	103
3.4.9.1	Plot an Ortep Diagram	103
3.4.9.2	Plot a Packing Diagram	104
3.5	Synthesis and Crystallization	105
3.5.1	Compound 1	105
3.5.2	Compound 2	106
3.5.3	Compound 3	106
3.5.4	Compound 4	106
3.5.5	Compound 5	107
3.5.6	Compound 6	107
3.5.7	Compound 7	108
3.5.8	Compound 8	108

3.5.9	Compound 9	108
3.5.10	Compound 10	109
3.5.11	Compound 11	109
3.5.12	Compound 12	110
3.5.13	Compound 13	110
3.5.14	Compound 14	110
3.5.15	Compound 15	111

CHAPTER 4 – RESULTS AND DISCUSSION

4.1	Compound 1	112
4.1.1	Data Collection	113
4.1.2	Discussion	114
4.1.3	Refinement	116
4.2	Compound 2	118
4.2.1	Data Collection	119
4.2.2	Discussion	120
4.2.3	Refinement	123
4.3	Compound 3	125
4.3.1	Data Collection	126
4.3.2	Discussion	127
4.3.3	Refinement	132
4.4	Compound 4	133
4.4.1	Data Collection	134
4.4.2	Discussion	135
4.4.3	Refinement	138
4.5	Compound 5	139
4.5.1	Data Collection	140
4.5.2	Discussion	141
4.5.3	Refinement	144
4.6	Compound 6	145
4.6.1	Data Collection	146

4.6.2	Discussion	147
4.6.3	Refinement	150
4.7	Compound 7	151
4.7.1	Data Collection	152
4.7.2	Discussion	153
4.7.3	Refinement	157
4.8	Compound 8	158
4.8.1	Data Collection	159
4.8.2	Discussion	160
4.8.3	Refinement	164
4.9	Compound 9	165
4.9.1	Data Collection	166
4.9.2	Discussion	167
4.9.3	Refinement	171
4.10	Compound 10	172
4.10.1	Data Collection	173
4.10.2	Discussion	174
4.10.3	Refinement	177
4.11	Compound 11	179
4.11.1	Data Collection	180
4.11.2	Discussion	181
4.11.3	Refinement	184
4.12	Compound 12	186
4.12.1	Data Collection	187
4.12.2	Discussion	188
4.12.3	Refinement	191
4.13	Compound 13	193
4.13.1	Data Collection	194
4.13.2	Discussion	195
4.13.3	Refinement	199
4.14	Compound 14	200

4.14.1	Data Collection	201
4.14.2	Discussion	202
4.14.3	Refinement	206
4.15	Compound 15	207
4.15.1	Data Collection	208
4.15.2	Discussion	209
4.15.3	Refinement	213
CHAPTER 5 – SUMMARY AND CONCLUSION		
5.1	1,2,4-Triazole Derivatives	215
5.1.1	Compounds Possessing 4,5-Dihydro-1 <i>H</i> -1,2,4-triazole Moiety	215
5.1.2	Compounds Possessing 4 <i>H</i> -1,2,4-Triazole Moiety	217
5.2	Pyrazole Derivatives	218
5.2.1	Compound Possessing 2,5-Dihydro-1 <i>H</i> -pyrazole Moiety	218
5.2.2	Compound Possessing 4,5-Dihydro-1 <i>H</i> -pyrazole Moiety	219
5.2.3	Compounds Possessing 1 <i>H</i> -Pyrazole Moiety	220
5.3	Recommendation for Future Research	222
REFERENCES		223
APPENDIXES		
LIST OF PUBLICATIONS		

LIST OF TABLES

	Page
Table 2.1	The seven crystal systems 19
Table 2.2	The 14 Bravais lattices 20
Table 2.3	Limiting conditions for unit cell type 36
Table 2.4	Limiting conditions for common screw axes 37
Table 2.5	Limiting condition for glide planes 37
Table 2.6	<i>Cis</i> - and <i>trans</i> -1,2-dichloroethene 66
Table 4.1	Crystal data of Compound 1 113
Table 4.2	Hydrogen bond geometry of Compound 1 116
Table 4.3	Crystal data of Compound 2 119
Table 4.4	Hydrogen bond geometry of Compound 2 122
Table 4.5	Crystal data of Compound 3 126
Table 4.6	Hydrogen bond geometry of Compound 3 131
Table 4.7	Crystal data of Compound 4 134
Table 4.8	Hydrogen bond geometry of Compound 4 137
Table 4.9	Crystal data of Compound 5 140
Table 4.10	Hydrogen bond geometry of Compound 5 143
Table 4.11	Crystal data of Compound 6 146
Table 4.12	Hydrogen bond geometry of Compound 6 149
Table 4.13	Crystal data of Compound 7 152
Table 4.14	Hydrogen bond geometry of Compound 7 156
Table 4.15	Crystal data of Compound 8 159
Table 4.16	Hydrogen bond geometry of Compound 8 163
Table 4.17	Crystal data of Compound 9 166
Table 4.18	Hydrogen bond geometry of Compound 9 171
Table 4.19	Crystal data of Compound 10 173
Table 4.20	Hydrogen bond geometry of Compound 10 177
Table 4.21	Crystal data of Compound 11 180

Table 4.22	Hydrogen bond geometry of Compound 11	184
Table 4.23	Crystal data of Compound 12	187
Table 4.24	Hydrogen bond geometry of Compound 12	191
Table 4.25	Crystal data of Compound 13	194
Table 4.26	Hydrogen bond geometry of Compound 13	199
Table 4.27	Crystal data of Compound 14	201
Table 4.28	Hydrogen bond geometry of Compound 14	206
Table 4.29	Crystal data of Compound 15	208
Table 4.30	Hydrogen bond geometry of Compound 15	213
Table 5.1	Comparison of bond lengths of 4,5-dihydro-1 <i>H</i> -1,2,4-triazole moiety of Compounds 1, 2, 3, 4 and 5	216
Table 5.2	Comparison of angles of 4,5-dihydro-1 <i>H</i> -1,2,4-triazole moiety of Compounds 1, 2, 3, 4 and 5	216
Table 5.3	Comparison of bond lengths of 4 <i>H</i> -1,2,4-triazole moiety of Compounds 6, 7, 8 and 9	218
Table 5.4	Comparison of angles of 4 <i>H</i> -1,2,4-triazole moiety of Compounds 6, 7, 8 and 9	218
Table 5.5	Bond lengths of 2,5-dihydro-1 <i>H</i> -pyrazole moiety of Compound 10	219
Table 5.6	Angles of 2,5-dihydro-1 <i>H</i> -pyrazole moiety of Compound 10	219
Table 5.7	Bond lengths of 4,5-dihydro-1 <i>H</i> -pyrazole moiety of Compound 11	220
Table 5.8	Angles of 4,5-dihydro-1 <i>H</i> -pyrazole moiety of Compound 11	220
Table 5.9	Comparison of bond lengths of 1 <i>H</i> -pyrazole moiety of Compounds 12, 13, 14 and 15	221
Table 5.10	Comparison of angles of 1 <i>H</i> -pyrazole moiety of Compounds 12, 13, 14 and 15	221

LIST OF FIGURES

		Page
Figure 1.1	Schematic diagram of 1,2,4-triazole	3
Figure 1.2	Einhorn-Brunner reaction scheme	4
Figure 1.3	Pellizzari reaction scheme	5
Figure 1.4	Schematic structure of fluconazole, containing two 1,2,4-triazole moieties	5
Figure 1.5	Schematic structure of itraconazole, containing two 1,2,4-triazole moieties	5
Figure 1.6	Schematic diagram of pyrazole	7
Figure 1.7	Pyrazole derivatives reaction scheme	8
Figure 1.8	Schematic structure of Celecoxib, containing a pyrazole moiety	9
Figure 1.9	Schematic structure of Metamizole sodium, containing a pyrazole moiety	9
Figure 2.1	Continuous X-ray spectra as a function of accelerating voltage	13
Figure 2.2	X-ray Spectra with characteristic peaks	14
Figure 2.3	Cross-sectional schematic of a sealed filament X-ray tube	16
Figure 2.4	Unit Cell	18
Figure 2.5	Construction showing conditions for diffraction	21
Figure 2.6	Diffraction in terms of the reciprocal lattice	24
Figure 2.7	Sections through the sphere of reflection and the limiting sphere ..	25
Figure 2.8	Combination of two waves, $f_1 e^{i\phi_1}$ and $f_2 e^{i\phi_2}$ as vectors on an Argand diagram	27
Figure 2.9	Combination of N waves ($N = 6$) on an Argand diagram	28
Figure 2.10	Atomic scattering factor	30
Figure 2.11	Structure factor $\mathbf{F}(hkl)$ plotted on an Argand diagram	32
Figure 2.12	Relationship between $\mathbf{F}(hkl)$ and $\mathbf{F}(\bar{h}\bar{k}\bar{l})$	35
Figure 2.13	One-dimensional periodic function, of repeat a	37

Figure 2.14	Illustration of primary extinction	49
Figure 2.15	Mosaic structure of a real crystal	50
Figure 2.16	Geometry of the calculation of interatomic distances and angles ..	57
Figure 2.17	Torsion angle $\chi(1,2,3,4)$	59
Figure 2.18	Commonly observed conformations of six-membered rings	64

Figure 3.1	Schematic diagram of the APEXII system	70
Figure 3.2	SMART APEXII goniometer components	71
Figure 3.3	Main window of APEX2 program	76
Figure 3.4	Flow chart of solving a structure	79
Figure 3.5	Goniometer head	81
Figure 3.6	The SaintChart	89
Figure 3.7	Main window of XPREP program	91
Figure 3.8	Ten cycles of least-square refinement	97
Figure 4.1	Schematic diagram of Compound 1	112
Figure 4.2	Molecular structure of Compound 1	114
Figure 4.3	Crystal packing of Compound 1	115
Figure 4.4	Schematic diagram of Compound 2	118
Figure 4.5	Molecular structure of Compound 2	120
Figure 4.6	Crystal packing of Compound 2	122
Figure 4.7	Schematic diagram of Compound 3	125
Figure 4.8	Molecular structure of Compound 3	127
Figure 4.9	Superposition of molecule <i>B</i> (solid lines) on molecule <i>A</i> (dashed lines)	129
Figure 4.10	Crystal packing of Compound 3	130
Figure 4.11	Schematic diagram of Compound 4	133
Figure 4.12	Molecular structure of Compound 4	135
Figure 4.13	Crystal packing of Compound 4	137
Figure 4.14	Schematic diagram of Compound 5	139
Figure 4.15	Molecular structure of Compound 5	141
Figure 4.16	Crystal packing of Compound 5	143
Figure 4.17	Schematic diagram of Compound 6	145
Figure 4.18	Molecular structure of Compound 6	147
Figure 4.19	Crystal packing of Compound 6	149
Figure 4.20	Schematic diagram of Compound 7	151
Figure 4.21	Molecular structure of Compound 7	153

Figure 4.22	Superposition of Compound 7 (solid lines) on Compound 6 (dashed lines)	155
Figure 4.23	Crystal packing of Compound 7	156
Figure 4.24	Schematic diagram of Compound 8	158
Figure 4.25	Molecular structure of Compound 8	160
Figure 4.26	Superposition of Compound 8 (solid lines) on Compound 6 (dashed lines)	162
Figure 4.27	Crystal packing of Compound 8	163
Figure 4.28	Schematic diagram of Compound 9	165
Figure 4.29	Molecular structure of Compound 9	167
Figure 4.30	Superposition of Compound 9 (solid lines) on Compound 6 (dashed lines)	169
Figure 4.31	Crystal packing of Compound 9	170
Figure 4.32	Schematic diagram of Compound 10	172
Figure 4.33	Molecular structure of Compound 10	174
Figure 4.34	Crystal packing of Compound 10	176
Figure 4.35	Schematic diagram of Compound 11	179
Figure 4.36	Molecular structure of Compound 11	181
Figure 4.37	Crystal packing of Compound 11	183
Figure 4.38	Schematic diagram of Compound 12	186
Figure 4.39	Molecular structure of Compound 12	188
Figure 4.40	Crystal packing of Compound 12	190
Figure 4.41	Schematic diagram of Compound 13	193
Figure 4.42	Molecular structure of Compound 13	195
Figure 4.43	Superposition of Compound 13 (solid lines) on Compound 12 (dashed lines)	197
Figure 4.44	Crystal packing of Compound 13	198
Figure 4.45	Schematic diagram of Compound 14	200
Figure 4.46	Molecular structure of Compound 14	202
Figure 4.47	Superposition of Compound 14 (solid lines) on Compound 12 (dashed lines)	204

Figure 4.48	Crystal packing of Compound 14	205
Figure 4.49	Schematic diagram of Compound 15	207
Figure 4.50	Molecular structure of Compound 15	209
Figure 4.51	Superposition of Compound 15 (solid lines) on Compound 12 (dashed lines)	211
Figure 4.52	Crystal packing of Compound 15	212
Figure 5.1	Schematic diagram of 4,5-dihydro-1 <i>H</i> -1,2,4-triazole moiety	216
Figure 5.2	Schematic diagram of 4 <i>H</i> -1,2,4-triazole moiety	217
Figure 5.3	Schematic diagram of 2,5-dihydro-1 <i>H</i> -pyrazole moiety	219
Figure 5.4	Schematic diagram of 4,5-dihydro-1 <i>H</i> -pyrazole moiety	220
Figure 5.5	Schematic diagram of 1 <i>H</i> -pyrazole moiety	221

LIST OF PLATES

	Page
Plate 3.1 The Bruker SMART APEXII CCD diffractometer in X-ray Crystallography Unit, School of Physics, USM	68
Plate 3.2 The Bruker APEXII DUO CCD diffractometer in X-ray Crystallography Unit, School of Physics, USM	69

STRUKTUR-STRUKTUR HABLUR DAN ANALISIS-ANALISIS SEBATIAN 1,2,4-TRIAZOL DAN PIRAZOL

ABSTRAK

Penyelidikan ini adalah bertujuan untuk mengkaji struktur-struktur hablur bagi sebatian-sebatian 1,2,4-triazol dan pirazol yang berperanan penting dalam aspek biologi dan farmakologi dengan kaedah kristalografi sinar-X hablur tunggal. Satu siri yang terdiri daripada sembilan sebatian bagi terbitan 1,2,4-triazol dan satu siri yang terdiri daripada enam sebatian bagi terbitan pyrazol disintesis dan dihablur untuk mendapatkan hablur tunggal. Data dikumpul dengan menggunakan diffraktometer-diffraktometer CCD Bruker SMART APEXII atau Bruker APEXII DUO. Struktur diselesaikan dengan kaedah terus dan disempurnakan dengan kaedah kuasa-dua terkecil. Parameter-parameter geometri dan penyusunan hablur diperoleh dan akhirnya perbandingan mudah telah dilakukan untuk beberapa struktur yang berkaitan. Keputusan kajian menunjukkan lapan daripada sebatian tersebut telah menghablur dalam kumpulan ruang monoklinik $P2_1/c$, lima dalam kumpulan ruang triklinik $P\bar{1}$ manakala dua lagi dalam kumpulan ruang monoklinik $C2/c$. Parameter-parameter geometri yang diperhati adalah dalam julat normal dan adalah konsisten dengan yang diperhati dalam struktur-struktur yang berkaitan. Tiada ikatan hidrogen antara molekul diperhati untuk dua sebatian manakala sebatian-sebatian yang lain membentuk ikatan hidrogen antara molekul dalam struktur hablur. Interaksi lemah antara molekul juga dapat diperhati dalam beberapa sebatian tersebut. Sebagai perbandingan, walaupun beberapa struktur yang berkaitan dihablur dalam kumpulan

ruang yang berbeza, struktur-struktur hablur tersebut adalah berpadanan dan mempunyai persamaan dalam geometri molecular.

**CRYSTAL STRUCTURES AND ANALYSIS
OF 1,2,4-TRIAZOLE AND PYRAZOLE COMPOUNDS**

ABSTRACT

The purpose of this research is to study the crystal structures of some biologically and pharmacologically important 1,2,4-triazole and pyrazole compounds by single crystal X-ray crystallography method. A series of nine compounds of 1,2,4-triazole derivatives and a series of six compounds of pyrazole derivatives were synthesized and crystallized to obtain single crystals. The data was collected using either Bruker SMART APEXII or Bruker APEXII DUO CCD area-detector diffractometers. The structures were solved by direct methods and refined by least-squares method. The geometrical parameters as well as crystal packing were obtained and finally simple comparisons were undertaken for some closely related structures. Results showed that eight of the compounds crystallized in the monoclinic space group $P2_1/c$, five in the triclinic space group $P\bar{1}$ and the remaining two in the monoclinic space group $C2/c$. The geometrical parameters observed are within normal ranges and consistent to those observed in related structures. No intermolecular hydrogen bond is observed for two compounds whereas the remaining compounds form hydrogen-bonded crystal structures. Weak intermolecular interactions are also observed in some of these compounds. For comparison, although some closely related structures crystallized in different space groups, they are having closely similar molecular geometries and fit fairly well with each other.

CHAPTER 1 – INTRODUCTION

In this thesis, a series of nine compounds of 1,2,4-triazole derivatives (**Compounds 1, 2, 3, 4, 5, 6, 7, 8 and 9**) and a series of six compounds of pyrazole derivatives (**Compounds 10, 11, 12, 13, 14 and 15**) were determined and analyzed by single crystal X-ray analysis method. The crystal samples were synthesized and crystallized by fellow researchers from Department of Studies in Chemistry, Mangalore University, Mangalagangothri, Mangalore, India and Department of Chemistry, National Institute of Technology-Karnataka, Surathkal, Mangalore, India.

All the crystal data were collected using either Bruker SMART APEXII or Bruker APEXII DUO CCD area-detector diffractometers (Bruker, 2009) at X-ray Crystallography Unit, School of Physics, Universiti Sains Malaysia (USM), Penang, Malaysia. The experimental results obtained were analyzed and have been published in *Acta Crystallographica Section E: Structure Reports Online*.

In this chapter, brief introductions of X-ray crystallography, general backgrounds and applications of 1,2,4-triazole and pyrazole derivatives as well as the research objective are presented. Basic principles of X-rays structure analysis are discussed in details in the next chapter.

1.1 X-ray Crystallography

X-ray crystallography is an analytical technique in which X-ray diffraction methods are employed to determine the actual three-dimensional arrangement of atoms in a crystalline structure. The science of X-ray crystallography originated with the discovery by Max von Laue in 1912 that crystals diffract X-ray radiations. Since then, single crystal

X-ray crystallography has developed into the most powerful method for obtaining the atomic arrangement in crystalline state.

Structure analysis by X-ray crystallography can be applied to a wide range of structure sizes, from small organic molecules and simple salts, to complex minerals, synthetically prepared inorganic and organo-metallic complexes, natural product compounds as well as to biological macromolecules, such as proteins and viruses.

The precise information of molecular geometry is important in nearly all fields of chemical and biological researches. The three-dimensional atomic coordinates can be easily obtained from the comprehensive crystallographic databases such as the Cambridge Structural Database (CSD) and Protein Data Bank. Crystallographic analyses are always the starting point for molecular modeling as well as drug design. In fact, many of most significant advances in structural chemistry and structural biology are based upon X-ray crystallography analyses.

Generally, the results obtained from X-ray crystallography analyses are complementary to other commonly used solid-state techniques such as X-ray powder diffraction, solid-state NMR, EPR, FT-IR and Raman spectroscopy, and neutron diffraction. Chemists also routinely use such techniques as nuclear magnetic resonance, infrared and ultraviolet spectroscopy, mass spectrometry, x-ray fluorescence, and elemental analysis for the identification and characterization of compounds prepared. After suitable analysis and interpretation, the experimental results obtained from these techniques may yield important information concerning the composition and structure of the compound. However, such information is always incomplete, fragmentary and ambiguous. There are a number of classes of chemical compounds such as natural product compounds, organo-metallic complexes, inorganic salts, metal cluster systems,

organic and inorganic reaction products for which the complete structure cannot be deduced even with all of the other methods combined. X-ray crystallography is uniquely capable of unambiguously determining the complete three-dimensional molecular structures (including the absolute stereochemistry) of chemical substances.

1.2 1,2,4-Triazole Derivatives

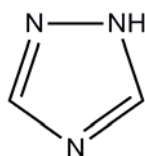

Figure 1.1 Schematic diagram of 1,2,4-triazole

1,2,4-Triazole [systematic name: 1*H*-1,2,4-triazole], with molecular formula $C_2H_3N_3$, is one of a class of simple organic heterocyclic compounds containing a five-membered ring composed of three nitrogen atoms and two carbon atoms at non-adjacent positions. A degree of respectability has been bestowed upon 1,2,4-triazole derivatives due to their various pharmacological activities such as analgesic (Amir & Shikha, 2004), anti-helminthic (Holla *et al.*, 2003), anti-oxidant (Kuş *et al.*, 2008), anti-tuberculosis (Walczak *et al.*, 2004), anti-cancer (Bekircan & Bektas, 2006; Sztanke *et al.*, 2008), anti-convulsant (Almasirad *et al.*, 2004; Bekircan & Bektas, 2006), anti-fungal (Amir *et al.*, 2008; Bekircan & Bektas, 2006; Holla *et al.*, 2003), anti-bacterial (Amir *et al.*, 2008; Bekircan & Bektas, 2006; Holla *et al.*, 2003), anti-microbial (Demirbas *et al.*, 2004; Sztanke *et al.*, 2008; Turan-Zitouni *et al.*, 2005), anti-tumor (Al-Soud *et al.*, 2003; Amir *et al.*, 2008; Demirbas *et al.*, 2004) and anti-inflammatory (Amir & Shikha, 2004; Amir

et al., 2008; Bekircan & Bektas, 2006; Sujith *et al.*, 2009). They also act as effective pesticides (Koparı *et al.*, 2005). Some of the present day drugs such as Ribavirin (anti-viral agent), Rizatriptan (anti-migraine agent), Alprazolam (anxiolytic agent), Fluconazole and Itraconazole (anti-fungal agents) are the best examples of potent molecules possessing the triazole nucleus (Fun *et al.*, 2009). Furthermore, the amino and mercapto groups of thio-substituted 1,2,4-triazole serve as readily accessible nucleophilic centers for the preparation of N-bridged heterocycles.

1.2.1 Preparation of 1,2,4-Triazole Derivatives

1,2,4-Triazole derivatives can be prepared using the Einhorn-Brunner reaction or Pellizzari reaction (1,2,4-Triazole, 2011).

Einhorn-Brunner Reaction:

The chemical reaction of imides with alkyl hydrazines to form a mixture of isomeric 1,2,4-triazole (Einhorn-Brunner reaction, 2011).

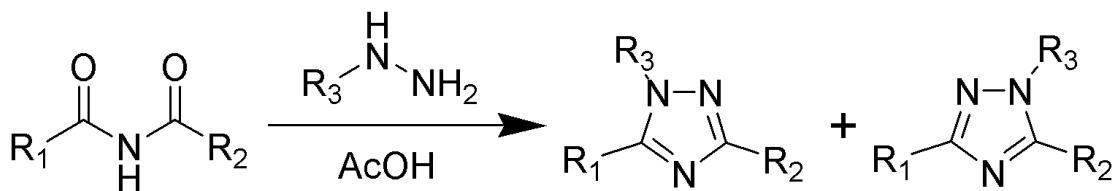

Figure 1.2 Einhorn-Brunner reaction scheme

Pellizzari Reaction:

The chemical reaction of amide with hydrazide to form a 1,2,4-triazole (Pellizzari reaction, 2011).

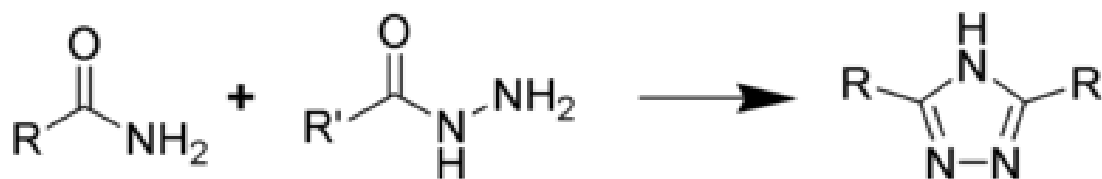

Figure 1.3 Pellizzari reaction scheme

1.2.2 Applications of 1,2,4-Triazole Derivatives

1,2,4-Triazole derivatives find use in a wide variety of applications, most notably as antifungals, such as fluconazole and itraconazole, which are used to treat fungal infections.

Fluconazole

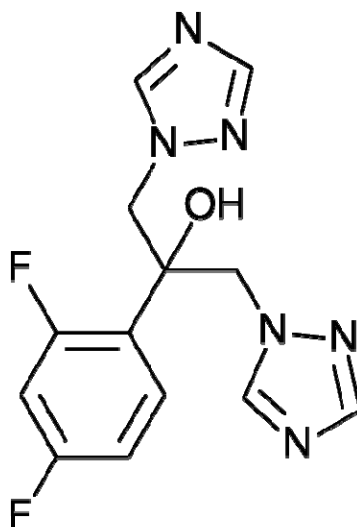

Figure 1.4 Schematic structure of fluconazole, containing two 1,2,4-triazole moieties

Fluconazole is used in the treatment and prevention of superficial and systemic fungal infections. It is commonly marketed under the trade name of **Diflucan®** or **Trican®** (Fluconazole, 2011).

Itraconazole

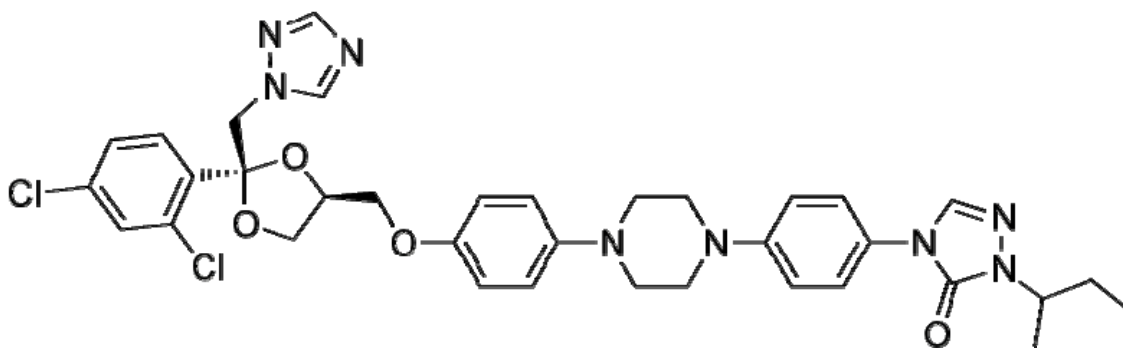

Figure 1.5 Schematic structure of itraconazole, containing two 1,2,4-triazole moieties

Itraconazole is a triazole anti-fungal agent that is prescribed to patients with fungal infections. It is invented in 1984, marketed as **Sporanox®** by Janssen Pharmaceutica (Itraconazole, 2011).

1.3 Pyrazole Derivatives

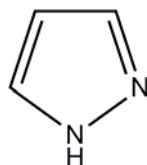

Figure 1.6 Schematic diagram of pyrazole

Pyrazole [systematic name: *1H*-pyrazole], with molecular formula $C_3H_4N_2$, is one of a class of simple organic heterocyclic compounds containing a five-membered ring composed of three carbon atoms and two nitrogen atoms in adjacent positions. Pyrazole derivatives are in general well-known nitrogen-containing heterocyclic compounds and various procedures have been developed for their synthesis. The 1,3-dipolar cycloaddition reaction with various dipolarphiles offers a convenient synthetic route for the preparation of pyrazole derivatives and been studied extensively (Rai *et al.*, 2008). The chemistry of pyrazole derivatives has been the subject of much interest due to their importance for various applications, and their widespread potential and proven biological and pharmacological activities such as analgesic (Tawab *et al.*, 1960), herbicidal (Rai *et al.*, 2008), tranquilizing (Rai *et al.*, 2008), anti-tumor (Rai *et al.*, 2008), anti-pyretic (Rai *et al.*, 2008, Tawab *et al.*, 1960), anti-inflammatory (Rathish *et al.*, 2009), anti-cancer (Sridhar & Perumal, 2003), anti-malarial (Sridhar & Perumal, 2003) and anti-hyperglycemic (Sridhar & Perumal, 2003) activities. Some alkyl- and aryl-substituted pyrazoles have a sharply pronounced sedative action on the central nervous system (Sridhar & Perumal, 2003). Certain alkyl pyrazoles also show significant bacteriostatic, bacteriocidal, fungicidal, analgesic and anti-pyretic activities (Sridhar & Perumal, 2003).

1.3.1 Preparation of Pyrazole Derivatives

Pyrazoles are produced synthetically through the reaction of α,β -unsaturated aldehydes with hydrazine and subsequent dehydrogenation (Pyrazole, 2011).

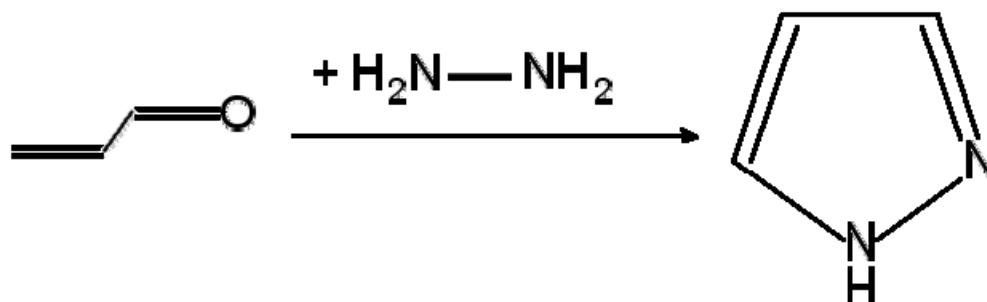

Figure 1.7 Pyrazole derivatives reaction scheme

1.3.2 Applications of Pyrazole Derivatives

Pyrazole derivatives are widely used as analgesic, anti-inflammatory, anti-pyretic, tranquilizing, anti-diabetic and anti-bacterial activities. Celecoxib and Metamizole sodium are two of the famous applications of pyrazole derivatives.

Celecoxib

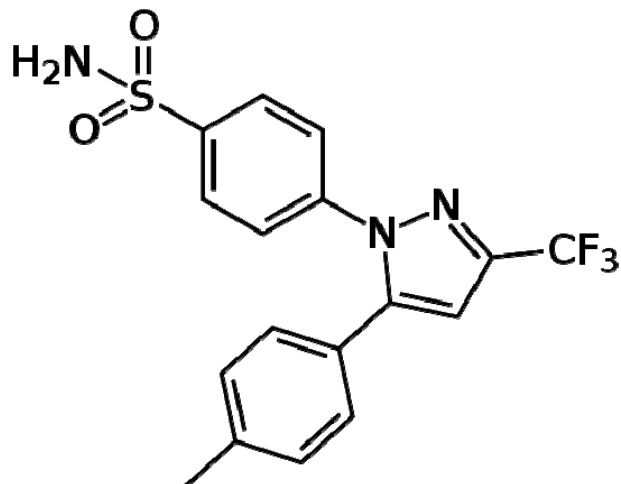

Figure 1.8 Schematic structure of Celecoxib, containing a pyrazole moiety

Celecoxib is a sulfa non-steroidal anti-inflammatory drug (NSAID) used in the treatment of osteoarthritis, rheumatoid arthritis, acute pain and menstrual pain. It is marketed by Pfizer, under the brand name of **Celebrex**[®] or **Celebra**[®] (Celecoxib, 2011).

Metamizole sodium

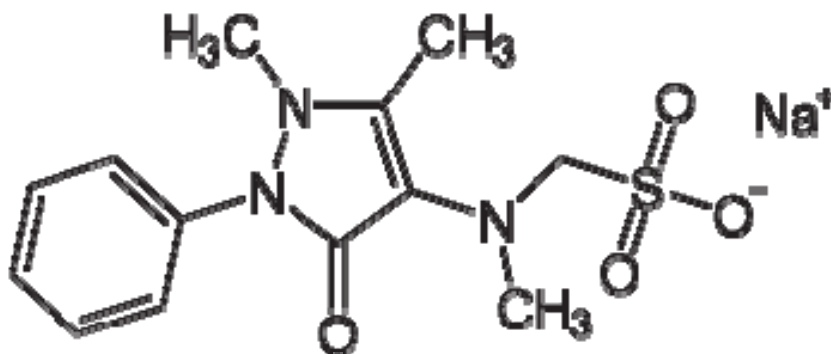

Figure 1.9 Schematic structure of Metamizole sodium, containing a pyrazole moiety

Metamizole sodium or dipyrone is a powerful analgesic and anti-pyretic drug. From a randomized, multinational study involving 555 children showed that metamizole sodium produced a significant greater body temperature reduction than ibuprofen and paracetamol, and it helped to maintain low body temperature for a longer duration. It is marketed in 1920, under various trade names including **Algozone®**, **Algocalmin®**, **Analgin®** and **Dipirona®**. It remained available worldwide until the 1970s, when it was discovered that the drug carries a small risk of causing agranulocytosis, which is lowering white blood cell amount. Several national medical authorities have banned it either totally or have restricted it to be available only on prescription (Metamizole, 2011).

1.4 Research Objective

Due to the proven biological and pharmacological importance of 1,2,4-triazole and pyrazole heterocyclic compounds, the main research objective is to determine and analyze the crystal structures of some unreported 1,2,4-triazole and pyrazole compounds. By using the single crystal X-ray structure analysis, complete set of crystal data of these previously unreported structures can be obtained. All geometric parameters in the molecular structure such as fractional atomic coordinates, bond lengths and angles as well as the three-dimensional crystal packing can also be elucidated.

- (a) The X-ray structure analysis of **Compound 1** {4-amino-3-(*p*-tolylloxymethyl)-1*H*-1,2,4-triazole-5(4*H*)-thione} was undertaken to study the biological importance of the 1,2,4-triazole derivatives.
- (b) The X-ray structure analysis of **Compound 2** {(*E*)-3-methyl-4-[(2-oxidoquinolin-1-ium-3-yl)methyleneamino]-1*H*-1,2,4-triazole-5(4*H*)-thione *N,N*-dimethylformamide solvate}, **Compound 3** {(*E*)-4-(4-hydroxy-3-methoxybenzylidene-

amino)-3-[1-(4-isobutylphenyl)ethyl]-1*H*-1,2,4-triazole-5(4*H*)-thione},

Compound 4 {(*E*)-4-[4-fluorobenzylidene]amino}-3-[1-(4-isobutylphenyl)ethyl]-1-(morpholinomethyl)-1*H*-1,2,4-triazole-5(4*H*)-thione methanol hemisolvate} and

Compound 5 {(*E*)-1-[(diphenylamino)methyl]-4-(4-fluorobenzylideneamino)-3-[1-(4-isobutylphenyl)ethyl]-1*H*-1,2,4-triazole-5(4*H*)-thione} were undertaken as part of ongoing research on Schiff base derivatives of 1,2,4-triazole and Mannich bases.

- (c) The X-ray structure analysis of **Compound 6** {4-[3-(phenoxyethyl)-7*H*-1,2,4-triazolo[3,4-*b*][1,3,4]thiadiazin-6-yl]-3-(*p*-tolyl)sydnone}, **Compound 7** {3-phenyl-4-{3-[(*p*-tolylloxy)methyl]-7*H*-1,2,4-triazolo[3,4-*b*][1,3,4]thiadiazin-6-yl]-sydnone}, **Compound 8** {4-{3-[(2-isopropyl-5-methylphenoxy)methyl]-7*H*-1,2,4-triazolo[3,4-*b*][1,3,4]thiadiazin-6-yl]-3-(*p*-tolyl)sydnone}, **Compound 9** {4-[3-(1-naphthylloxymethyl)-7*H*-1,2,4-triazolo[3,4-*b*][1,3,4]thiadiazin-6-yl]-3-*p*-tolylsydnone} and **Compound 10** {3-(2,3-dimethyl-5-oxo-1-phenyl-2,5-dihydro-1*H*-pyrazole-4-yl)sydnone} were undertaken as part of ongoing research on 1,2,4-triazole and pyrazole derivatives of sydnone nucleus.
- (d) The X-ray structure analysis of **Compound 11** {5-bromo-2-[5-(4-nitrophenyl)-3-phenyl-4,5-dihydro-1*H*-pyrazol-1-yl]pyrimidine} was undertaken to study the biological importance of the pyrazole derivatives.
- (e) The X-ray structure analysis of **Compound 12** {[3-(5-nitro-2-furyl)-1-phenyl-1*H*-pyrazol-4-yl](phenyl)methanone}, **Compound 13** {(4-methylphenyl)[3-(5-nitro-2-furyl)-1-phenyl-1*H*-pyrazol-4-yl]methanone}, **Compound 14** {(4-methylphenyl)[1-(4-methylphenyl)-3-(5-nitro-2-furyl)-1*H*-pyrazol-4-yl]methanone} and **Compound 15** {(4-chlorophenyl)[1-(4-methylphenyl)-3-(5-nitro-2-furyl)-1*H*-

pyrazol-4-yl]methanone} were undertaken as part of ongoing studies on synthetic route of pyrazole derivatives by 1,3-dipolar cycloaddition carrying nitrofuranyl moiety.

CHAPTER 2 – BASIC PRINCIPLES OF X-RAY STRUCTURE ANALYSIS

2.1 Generation of X-rays

X-rays, first discovered by Wilhelm Conrad Roentgen in 1892, are electromagnetic radiations with wavelength, λ in the range of $0.1 < \lambda < 100 \text{ \AA}$. Continuous X-rays are produced when high speed electrons hit a target material and are rapidly decelerated. The minimum wavelength of these continuous X-rays obtained is given by

$$E = eV = \frac{hc}{\lambda} \quad (2.1)$$

$$\lambda_{\min} = \frac{hc}{eV} \quad (2.2)$$

where h = Planck's constant = $6.626 \times 10^{-34} \text{ J} \cdot \text{s}$

c = speed of light = $2.998 \times 10^8 \text{ ms}^{-1}$

e = electron charge = $1.602 \times 10^{-19} \text{ C}$

V = accelerating voltage

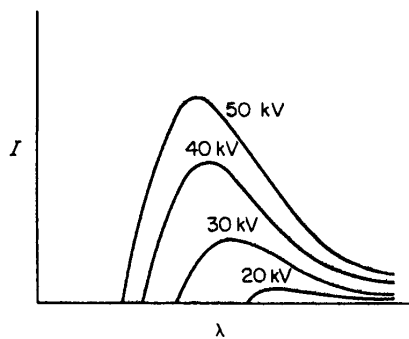

Figure 2.1 Continuous X-ray spectra as a function of accelerating voltage
(Stout & Jensen, 1968)

The maximum intensity of the X-ray spectra occurs at longer wavelength. As the accelerating voltage is increased, not only peak intensity and minimum wavelength are moved to shorter, more penetrating wavelengths, but also the total intensity is increased even though the electron current remains the same (Figure 2.1).

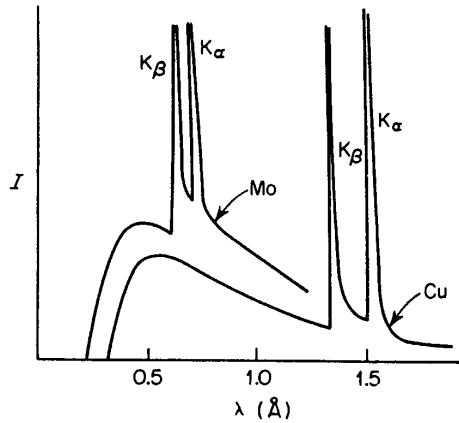

Figure 2.2 X-ray Spectra with characteristic peaks: Mo $K\alpha$ at 50 kV;
Cu $K\alpha$ at 35 kV (Stout & Jensen, 1968)

The distribution of intensity is primarily dependent on the accelerating voltage and only to a smaller extent of the target material. In addition, X-ray spectra show a number of sharp peaks of high intensity whose positions change from one material to another (Figure 2.2). These peaks are characteristic lines for the element of the target material. When the electrons bombarding the target reach the threshold potentials, they are capable of knocking electrons out of their innermost atomic orbitals. At a certain energy value, they can remove electrons from the innermost shell (K shell). This causes a vacancy in the K shell and it is filled by the descent of an electron from the higher shells (L or M shells). The difference in potential energy from the higher to the lower level

appears as radiation. A nearly monochromatic transition line is given out as the energy levels of the shells are well defined. The principal peaks are given as

$$K_{\alpha 1}, K_{\alpha 2} \quad L \rightarrow K$$

$$K_{\beta 1}, K_{\beta 2} \quad M \rightarrow K$$

The characteristic lines shift to shorter wavelength as the atomic number, Z of the target material increases. In principle, almost any desired value for the K_{α} line can be obtained by selecting an appropriate target material.

For X-ray diffraction analysis, the radiation used should be as nearly monochromatic as possible. The K_{α} lines fulfill this requirement, but the presence of the accompanying K_{β} lines is a nuisance. To overcome this, crystal monochromator can be used to remove the K_{β} line (Stout & Jensen, 1968).

2.1.1 X-ray Tube

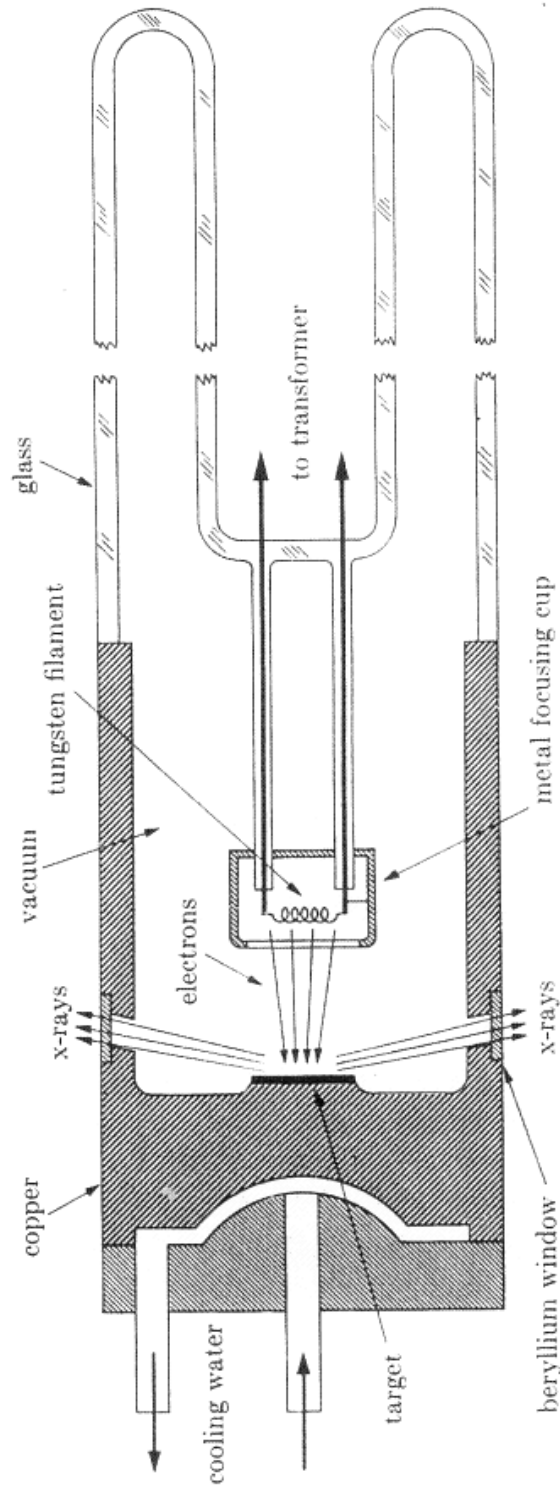

Figure 2.3 Cross-sectional schematic of a sealed filament X-ray tube (Cullity, 1967)

The internal construction of a sealed filament X-ray tube is shown in Figure 2.3. It consists of an evacuated glass envelope which insulates the anode at one end from the cathode at the other end. One lead of the high-voltage transformer (normally 30 to 50 kV for X-ray diffraction work) is connected to the filament and the other is grounded. The target anode is being grounded by its own water cooling system. Electrons emitted by the heated tungsten filament being rapidly accelerated to the target anode by the high voltage across the tube. The focusing cup, which is a small metal cup surrounding the heated filament, repels the electrons and focuses them into a narrow region of the target, so-called the focal spot. X-ray radiations are emitted from the focal spot in all directions and leave the tube through two or more windows which are normally made of beryllium.

The conversion of incident energy of the electron beam into X-rays is a very inefficient process. Less than 1 % of incident energy is converted into X-ray radiations, the remaining heat energy is dissipated by the water cooling system. The most important properties of deciding an X-ray tube is the choice of the target material and the radiation filter. For single crystal diffraction work, Mo and Cu tubes are adequate for 99 % of all problems. The size and shape of the focal spot and the power are important as well since the X-ray intensity depends on these two parameters. Within limits, the size of the focal spot should be as small as possible in order to concentrate the electron energy into a small area of the target and hence produce a high-intensity beam of X-rays. The maximum power rating is the limit of amount of heat that can be dissipated by the target without damage to the X-ray tube (Cullity, 1967).

2.2 Crystal Systems

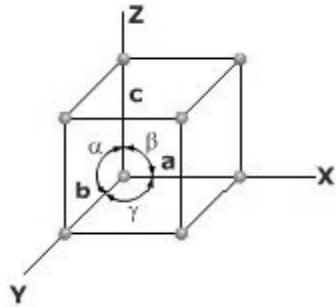

Figure 2.4 Unit Cell



There are seven three-dimensional coordinate systems which are useful in describing crystals and they are the basis for the classification. Generally, a unit cell is characterized by six parameters, *i.e.* the three axial lengths (a , b and c) and three inter-axial angles (α , β and γ) (Figure 2.4). By giving special values to these parameters, we can produce unit cells of various shapes and therefore various types of point lattices. It turns out that only seven different types of cells are necessary to include all the possible point lattices. These correspond to the seven crystal systems into which all crystals can be classified and they are listed in Table 2.1.

Table 2.1 The seven crystal systems (Stout & Jensen, 1967)

Crystal system	No. of independent Parameters	Parameters	Lattice symmetry
Triclinic	6	$a \neq b \neq c ; \alpha \neq \beta \neq \gamma$	$\bar{1}$
Monoclinic	4	$a \neq b \neq c ; \alpha = \gamma = 90^\circ ; \beta \neq 90^\circ$	$\frac{2}{m}$
Orthorhombic	3	$a \neq b \neq c ; \alpha = \beta = \gamma = 90^\circ$	mmm
Tetragonal	2	$a = b \neq c ; \alpha = \beta = \gamma = 90^\circ$	$\frac{4}{m}mm$
Rhombohedral	2	$a = b = c ; \alpha = \beta = \gamma \neq 90^\circ$	$\bar{3}m$
Hexagonal	2	$a = b \neq c ; \alpha = \beta = 90^\circ ; \gamma = 120^\circ$	$\frac{6}{m}mm$
Cubic	1	$a = b = c ; \alpha = \beta = \gamma = 90^\circ$	$m\bar{3}m$

Different primitive point lattices can simply be obtained by putting points at the corners of the unit cell of the seven crystal systems. However, there are other arrangements of points (non-primitive lattices) which fulfill the requirements of a point lattice, namely, that each point has identical surroundings. In 1848, Bravais demonstrated that there are a total of 14 possible point lattices and no more and thus they are called as the Bravais lattices. These 14 Bravais lattices consist of seven primitive and seven non-primitive lattices and they are listed in Table 2.2 (Cullity, 1967).

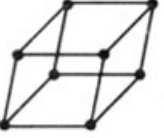
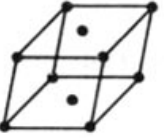
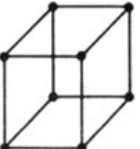
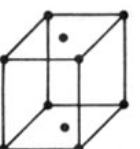
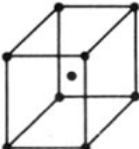
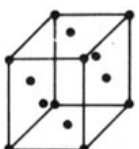
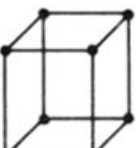
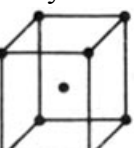
Table 2.2 The 14 Bravais lattices (Cullity, 1967)

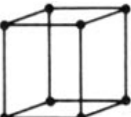
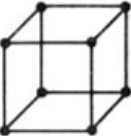
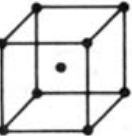
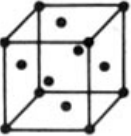
Crystal system	Bravais lattices			
Triclinic	Primitive 			
Monoclinic	Primitive 	End-centered 		
Orthorhombic	Primitive 	End-centered 	Body-centered 	Face-centered 
Tetragonal	Primitive 	Body-centered 		
Rhombohedral	Primitive 			
Hexagonal	Primitive 			
Simple cubic	Primitive 	Body-centered 	Face-centered 	

2.3 X-ray Diffraction

Although X-rays had been discovered by Roentgen in 1895, but their nature was not known. Following the experimental observation of X-ray diffraction in early 1912, Max von Laue showed that the wave characteristics of X-ray could be described in terms of diffraction from a three-dimensional grating. In the same year, W. L. Bragg noticed the similarity of diffraction to ordinary reflection and therefore he deduced a simple equation treating diffraction as “reflection” from planes in the lattice, deriving the well-known Bragg’s Law.

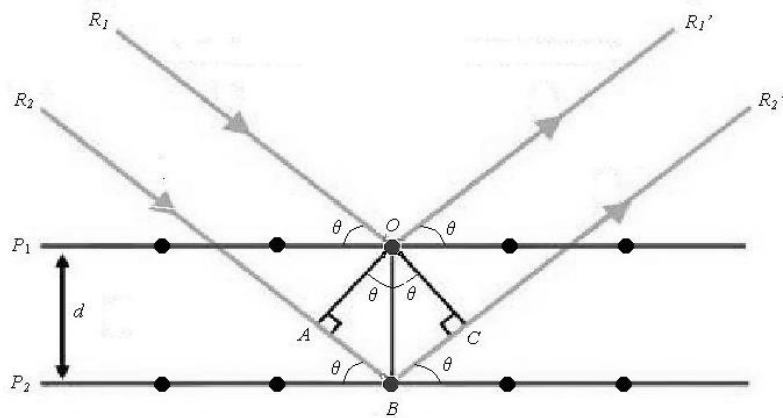

Figure 2.5 Construction showing conditions for diffraction

Consider an X-ray beam incident on two parallel planes (P_1 and P_2) with interplanar spacing of d (Figure 2.5). The parallel incident rays (R_1 and R_2) make an angle of θ with these incident planes. Assume that electrons at O and B will be forced to vibrate by the oscillating field of the incident beam and they will radiate in all directions as vibrating charges. For that particular direction where the parallel secondary rays (R_1' and R_2') emerge at angle θ as if reflected from the planes, a diffracted beam of maximum intensity will result if the waves represented by these rays are in phase. It can be shown

that $\angle AOB = \angle BOC = \theta$ by dropping perpendicular from O to A and O to C , respectively. Therefore, $AB = BC$, and waves in ray R_2' will be in phase with those in R_1' if $AB + BC$ is an integral number of wavelengths λ ($AB + BC = 2AB$). This can be expressed by the equation

$$2AB = n\lambda \quad (2.3)$$

where n is an integer.

Using $\frac{AB}{OB} = \frac{AB}{d} = \sin \theta$, (2.3) becomes

$$2d \sin \theta = n\lambda \quad (2.4)$$

(2.4) is the Bragg's Law.

Since $\sin \theta \leq 1$

$$\frac{n\lambda}{2d} \leq 1 \quad (2.5)$$

When $n = 1$

$$\lambda \leq 2d \quad (2.6)$$

From (2.6), we notice that the radiation used must have wavelengths comparable to or smaller than twice the inter-atomic spacing, d in the crystal structure (Stout & Jensen, 1968).

2.3.1 Reciprocal Lattice

Consider Bragg's Law (2.4) in the form of

$$\sin \theta = \frac{n\lambda}{2d} \quad (2.7)$$

It can be seen that $\sin \theta$ is inversely proportional to the inter-planar spacing in the crystal lattice. Since $\sin \theta$ is a measure of the deviation of the diffracted beam from the direct beam, it is evident that crystal structures with large d will exhibit compressed diffraction patterns, and conversely for small d . Interpretation of X-ray diffraction patterns would be facilitated if the inverse-relation between $\sin \theta$ and d could be replaced by a direct one. This can be achieved by constructing a reciprocal lattice based on $1/d$, a quantity that varies directly as $\sin \theta$ (Stout & Jensen, 1968).

Relationships between direct and reciprocal lattices:

$$a = \frac{b^* c^* \sin \alpha^*}{V^*}; \quad a^* = \frac{bc \sin \alpha}{V} \quad (2.8)$$

$$b = \frac{c^* a^* \sin \beta^*}{V^*}; \quad b^* = \frac{ca \sin \beta}{V} \quad (2.9)$$

$$c = \frac{a^* b^* \sin \gamma^*}{V^*}; \quad c^* = \frac{ab \sin \gamma}{V} \quad (2.10)$$

$$V = abc[1 - \cos^2 \alpha - \cos^2 \beta - \cos^2 \gamma + 2 \cos \alpha \cos \beta \cos \gamma]^{1/2} \quad (2.11)$$

$$V^* = a^* b^* c^* [1 - \cos^2 \alpha^* - \cos^2 \beta^* - \cos^2 \gamma^* + 2 \cos \alpha^* \cos \beta^* \cos \gamma^*]^{1/2} \quad (2.12)$$

$$\sin \theta = \frac{\lambda}{2d_{hkl}} \quad (2.15)$$

$$2d \sin \theta = \lambda \quad (2.16)$$

(2.16) is just the Bragg's Law with $n = 1$.

Generally, this derivation implies that Bragg's law is fulfilled and reflection occurs whenever a reciprocal lattice point coincides with a circle constructed as described. The reflecting plane is perpendicular to OP , hence parallel to BP and it makes an angle of θ with OB . The direction of reflection is along OP . The construction is not limited to the a^*c^* section but holds for the whole sphere, the sphere of reflection. Thus for any point lying on the surface of this sphere, the same conditions hold as for point P in Figure 2.6 and the conditions for Bragg's Law reflection are fulfilled for the related direct space plane. By rotating the lattice about its origin, various reciprocal lattice points can be brought into coincidence with the surface of sphere of reflection and the corresponding reflection can be observed.

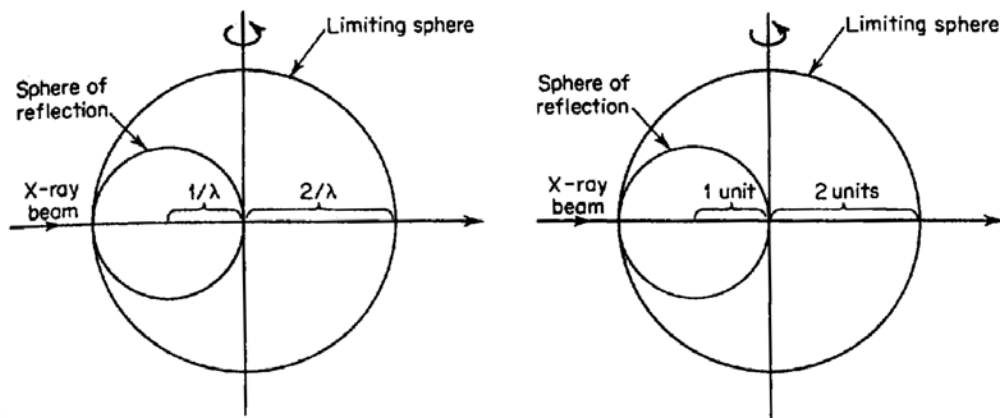

Figure 2.7 Sections through the sphere of reflection and the limiting sphere:

(a) for reciprocal lattice defined as $1/d$

(b) for reciprocal lattice defined as λ/d (Stout & Jensen, 1968)